

JAMAN PRODUCTS INC.

#6 Banahaw St., Amparo Subdivision
Brgy. Nagkaisang Nayan, Novaliches, Q.C.



COMPANY PROFILE

FABRICATION AND CASTING:

- Different types of brass
- Cast Iron
- Aluminum
- Floor Drains
- Roof Drains
- Cleanouts
- Gratings
- Manhole
- Cistern Cover
- Grease Trap and more

Tel. No.: 936-1926

925-8968

Email: jamanprods@gmail.com



HUMBLE BEGINNING

In 1990, Mr. Manuel Ang founded JAMAN METAL CRAFT, a sole proprietor welding shop metal business in Magsaysay Village in Tondo, Manila. He was popularly known in the neighborhood as Mr. JAMAN back then and manufactured various metal products such as but not limited to, cast iron, brass floor drain, brass dome type roof drain and floor strainers of various metals.

The JAMAN trademark was derived from the name Manuel Ang, Jr.: the letter "J" is from Junior, "A" from Ang, and "MAN" from the first three letters of his name, "Manuel".

In 2002, JAMAN PRODUCTS, INC. (JPI) was formed. A corporation with his sons and daughters - a current manufacturer, seller and distributor of JAMAN Branded strainers and drains.

Up to now, JAMAN PRODUCTS, INC. (JPI) is known for fabrication and casting of different kind of floor drains (brass and stainless), clean-outs, grease traps, interceptors, gratings and manholes. And we supply to government and private projects in the Philippines.

MISSION

Be the leading manufacturer of floor drains (brass and stainless), clean-outs, grease traps, interceptors, gratings and manholes in the Philippines.

VISION

Be the country's most trusted and preferred provider of floor drains (brass and stainless), clean-outs, grease traps, interceptors, gratings and manholes.

BOARD OF DIRECTORS

Mr. ROBERTO CHOI ANG - President

Mr. HUNG, SHUI HIN CHOI - Vice-President

Ms. IVY ANG - Stockholder

Ms. WING SAU ANG - Corporate Secretary

Ms. CHAN, TERESITA ANG - Corporate Treasurer

OFFICE

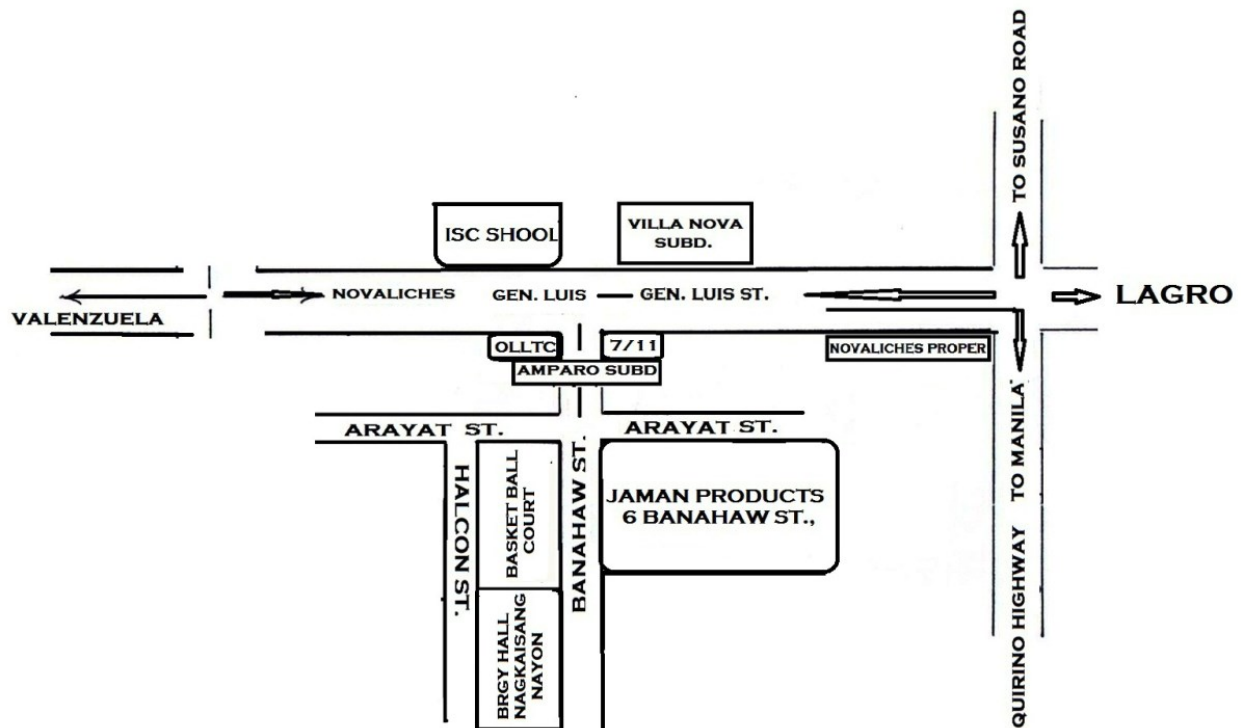

VICINITY MAP

JAMAN PRODUCTS INCORPORATED
6 BANAHAW ST., AMPARO SUBD.
BRGY. NAGKAISANG NAYON NOVALICHES Q.C.

ARTICLES OF INCORPORATION



REPUBLIC OF THE PHILIPPINES
SECURITIES AND EXCHANGE COMMISSION
SEC Building, EDSA, Greenhills
City of Mandaluyong, Metro Manila

COMPANY REG. No. A200203866

**CERTIFICATE OF FILING
OF
AMENDED ARTICLES OF INCORPORATION**

KNOW ALL PERSONS BY THESE PRESENTS:

THIS IS TO CERTIFY that the amended articles of Incorporation of the

JAMAN PRODUCTS, INC.
(Amending Article VII thereof)

copy annexed, adopted on **August 27, 2010** by a majority vote of the Board of Directors and by the vote of the stockholders owning or representing at least two-thirds of the outstanding capital stock, and certified under oath by the Secretary and a majority of the Board of Directors of the corporation was approved by the Commission on this date pursuant to the provision of Section 16 of the Corporation Code of the Philippines, Batas Pambansa Blg. 68, approved on May 1, 1980 and copies thereof are filed with the Commission.

Unless this corporation obtains or already has obtained the appropriate Secondary License from this Commission, this Certificate does not authorize it to undertake business activities requiring a Secondary License from this Commission such as, but not limited to acting as: broker or dealer in securities, government securities eligible dealer (GSED), investment adviser of an investment company, close-end or open-end investment company, investment house, transfer agent, commodity/financial futures exchange/broker/merchant, financing company, pre-need plan issuer, general agent in pre-need plans and time shares/club shares/membership certificates issuers or selling agents thereof. Neither does this Certificate constitute as permit to undertake activities for which other government agencies require a license or permit.

IN WITNESS WHEREOF, I have hereunto set my hand and caused the seal of this Commission to be affixed to this Certificate at Mandaluyong City, Metro Manila, Philippines, this 6th day of June, Twenty Thirteen.





FERDINAND B. SALES
Acting Director

Company Registration and Monitoring Department

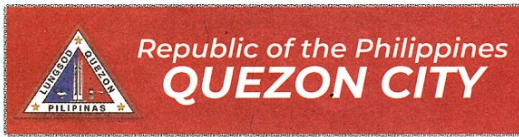

BUSINESS PERMIT

QCC.BPLD.BPD.F.02 (202



MAYOR'S PERMIT
Business Permits and Licensing Department

GF, Civic Center Bldg A, Quezon City Hall Complex, Elliptical Road, QC
 bpld@quezoncity.gov.ph 8988.4242 local 8174
 https://qcservices.quezoncity.gov.ph

| | | | |
|---|---|---|--------------------------------------|
| Mayors Permit No. 04-300569 | Type of Application RENEWAL | Official Receipt No. B-2023-000-002-0003899 | Date of Payment 03/24/2023 |
| Date Issued SEPTEMBER 5, 2023 | Valid Until SEPTEMBER 5, 2024 | Amount Paid 1,470,014.15 | Period Covered 1-4 2023 |
| Business Name JAMAN PRODUCTS, INC. | | | |
| Trade Name JAMAN PRODUCTS, INC. | | | |
| President CHAN, TERESITA A. | | | |
| Address 6 BANAHAW ST. AMPARO SUBD., SITIO KAPRE NAGKAISANG NAYON DISTRICT 5, QUEZON CITY | | | |
| Type of Business Organization CORPORATION | Proof of Business Registration SEC A200203866 | TIN 218-590-410-000 | SSS 03-9052031-3 |
| CONTRACTOR * FABRICATION OF METAL PRODUCTS OTHER BUSINESS AND BUSINESS WITH FIX RATES * DELIVERY TRUCK / VAN OPERATOR RETAILER * METAL PRODUCTS WHOLESALE * METAL PRODUCTS | | | |
| Area of Establishment 441.00 SQM | | Total No. of Employees Male: 7 Female: 4 | |
| Ancillary Clearance | | Clearance No. | Validity |
| Locational Certificate (ZAU) | | C20-R-GKT5CRJ1 | 2020-02-06 to 2025-02-06 |
| Sanitary Permit (QCHD) | | FOR COMPLIANCE | FOR COMPLIANCE |
| Fire Safety Inspection Certificate (BFP-QC) | | | |
| Barangay Clearance (BARANGAY NAGKAISANG NAYON) | | | |
| Traffic Clearance (TTMD) | | NOT REQUIRED | NOT REQUIRED |
| Environmental Clearance (DSQC) | | FOR COMPLIANCE | FOR COMPLIANCE |
| Veterinary Clearance (CVO) | | NOT REQUIRED | NOT REQUIRED |
| Market Clearance (MDAD) | | NOT REQUIRED | NOT REQUIRED |
| Liquor Clearance (BPLD) | | NOT REQUIRED | NOT REQUIRED |
| Security Clearance (DPQS) | | NOT REQUIRED | NOT REQUIRED |
| QC Tourism Certificate (QCTD) | | NOT REQUIRED | NOT REQUIRED |
| Occupational Permit of employees (BPLD): 0 | | | |

Subject to: COND. 1,2,3,4,5 & 6 ** TO COMPLY WITH ANCILLARY REMARKS AND FINDINGS AS SENT VIA EMAIL DURING EVALUATION OF PERMIT APPLICATION BY REGULATORY DEPARTMENTS/OFFICES WITHIN 45 DAYS. THIS PERMIT IS VALID ONE (1) YEAR FROM DATE OF ISSUE PURSUANT TO CITY ORDINANCE NO. SP-3013, S-2021, SUBJECT TO PROVISIONS OF APPLICABLE LAWS, ORDINANCES, RULES AND REGULATIONS PERTINENT TO THE CONDUCT OF BUSINESS. FAILURE TO COMPLY SHALL REVOKE/CANCEL THIS PERMIT.

For and By Authority of the City Mayor:
HON. MA. JOSEFINA G. BELMONTE



Remarks:
 * NON-TRANSFERABLE AND VALID ONLY WITH CORRESPONDING OFFICIAL RECEIPTS SHOWING PAYMENT OF PERMIT FEES AND CITY TAXES. ERASURE/ALTERATIONS WILL INVALIDATE THIS PERMIT.
 * FAILURE TO RENEW THIS BUSINESS PERMIT/LICENSE WITHIN THE PRESCRIBED PERIOD SHALL SUBJECT TO TAXPAYER TO A TWENTY-FIVE (25%) SURCHARGE OF THE PERMIT FEE.
 * THIS PERMIT SHALL BE POSTED CONSPICUOUSLY AT THE PLACE OF BUSINESS AND SHALL BE PRESENTED AND/OR SURRENDERED TO CONCERNED AUTHORITIES UPON DEMAND.
 * SURRENDER THIS PERMIT WITHIN 20 DAYS UPON CLOSURE OF BUSINESS TO AVOID PENALTY.



MA. MARGARITA T. SANTOS
City Government Department Head III

PRINTED BY: **NERMA CABALLERO**

FIRE SAFETY INSPECTION CERTIFICATE



Republic of the Philippines
 Department of the Interior and Local Government
BUREAU OF FIRE PROTECTION
 National Capital Region
 QUEZON CITY FIRE DISTRICT
 CITY HALL COMPOUND, DILIMAN, QUEZON CITY
 Tel NO. 435-0168/ 924-1922



FSIC NO. R 16-2021871 **09/29/2023**
Date

FIRE SAFETY INSPECTION CERTIFICATE

FOR CERTIFICATE OF OCCUPANCY
 FOR BUSINESS PERMIT (NEW/RENEWAL)
 OTHERS _____

TO WHOM IT MAY CONCERN:

By virtue of the provisions of RA 9514 otherwise known as the Fire Code of the Philippines of 2008, the application for **FIRE SAFETY INSPECTION CERTIFICATE** of **JAMAN PRODUCTS, INC., classified as MERCANTILE Occupancy**
(Name of Establishment)
 owned and managed by **JAMAN PRODUCTS, INC.** with postal address at **6 BANAHAW ST. AMPARO SUBD., SITIO KAPRE NAGKAISANG NAYON QC**
(Name of Owner/Representative)
(Address)

is hereby **GRANTED** after said building structure or facility has been duly inspected with the finding that it has fully complied with the fire safety and protection requirements of the Fire Code of the Philippines of 2008 and its Revised Implementing Rules and Regulations.

This certification is valid for **RETAILER/WHOLESALE/FABRICATION OF METAL PRODUCTS** occupying **1 storey bldg w/ an area of (063.00sqm) m. only.** valid until **Saturday, September 28, 2024**

Violation of Fire Code provisions shall cause this certificate *null and void* after appropriate proceeding and shall hold the owner liable to the penalties provided for by the said Fire Code.

Fire Code Fees: 233.30
 Amount Paid: _____
 O.R. Number: 02-2023-000
 Date: 03/24/2023

RECOMMEND APPROVAL:

FCINSP DOMINIC R SALVACION
 CHIEF, Fire Safety Enforcement Section

APPROVED:

FSUPT ROWENA H GOLLOD, DSC
 Caretaker/Deputy DFM
 CITY/MUNICIPAL FIRE MARSHAL

RBUS-2023-010483 R-BUS
 SFOT LUMBAGA, LEONATHAN YVES E.
 DATE: 09/29/2023

NOTE: "This Certificate does not take the place of any license required by law and is not transferable. Any change in the use of occupancy of the premises shall require a new certificate."

THIS CERTIFICATE SHALL BE POSTED CONSPICUOUSLY

PAALALA: "MAGHIGPIT NA IPINAGBABAWAL NG PAMUNUAN NG BUREAU OF FIRE PROTECTION SA MGA KAWANI NITO ANG MAGBENTA O MAGREKOMENDA NG ANUMANG BRAND NG FIRE EXTINGUISHER"

"FIRE SAFETY IS OUR MAIN CONCERN"

Applicant/Owner's COPY

04-390569

 ENCUCUCROJ - LORAIN N. IGNACIO

BFP-QSF-FSED-005 Rev. 03 (03.03.20)

BIR 2303-CERTIFICATE OF REGISTRATION

REPUBLIC OF THE PHILIPPINES
KAGAWARAN NG PANANALAPI
KAWANIHAN NG REVENUE DISTRICT NO. 028
REVENUE REGION NO. 08

BIR 2303
Form No. 2303
Revised July 1997

3RC0000726177
OCN

CERTIFICATE OF REGISTRATION

DEC 14 2015

TIN: 218-590-410-000
NAME: JAMAN PRODUCTS, INC.
REGISTRATION DATE: 06/25/2002

REGISTERED ADDRESS: NO. 6 BANAHAW ST AMPARO SUBD SITIO CAPRI NAGKAIKANG NAYON
AREA IX DIST II NOVALICHES QUEZON CITY

REGISTERED ACTIVITY(IES)
TAX TYPE

INCOME TAX
VALUE ADDED TAX
WITHHOLDING TAX

REGISTRATION FEE
WITHHOLDING TAX COMPENSATION
FINAL WITHHOLDING TAX

TRADE NAME

JAMAN PRODUCTS INC.

LINE OF BUSINESS / INDUSTRY

2899 MANUFACTURE OF OTHER FABRICATED METAL PRODUCTS
5190 OTHER WHOLESALING
5234 RETAIL SALE OF HARDWARE, PAINTS AND GLASS

REMARKS: ***Transferred-in from RDO 027

FILING OF REQUIRED TAX RETURNS TO CONFORM WITH ABOVE TAX TYPES WITH OR WITHOUT OPERATION TO AVOID PENALTIES

| INCOME TAX | | WITHHOLDING TAX - EXPANDED | | WITHIN 30 DAYS FROM REGISTRATION DATE THE FOLLOWING SHOULD BE ACCOMPLISHED | |
|--|--|--|--|--|--|
| SINGLE PROPRIETOR | CORP/PART ASSOC. | 1601E - Every 10th day of the following month | 1604E - Annual Info. Return - March 01 | *BOOKS OF ACCOUNTS | |
| 1st Qtr. APR 15 | 1st Qtr. MAY 30 | WITHHOLDING TAX - COMPENSATION | | *AUTHORITY TO PRINT INVOICES/RECEIPTS | |
| 2nd Qtr. AUG 15 | 2nd Qtr. NOV 29 | 1601-C - Every 10th day of the following month | 1604-CF Annual info. Return - Jan. 31 | RENEWAL OF ANNUAL REGISTRATION FEE ON OR BEFORE JANUARY 31 USING BIR FORM 0605 | |
| 3rd Qtr. NOV 15 | 3rd Qtr. APR 15 | PERCENTAGE TAX | | IMMEDIATELY INFORM THIS DISTRICT OFFICE IN CASE OF TRANSFER/CESSATION OF REGISTRATION AND OTHER CONCERNS BY FILING BIR FORM 1905 | |
| 1701 - Every 20th day of the following month | 2550Q - Every 25th day after the close of each quarter | 2551M - Every 20th day of the following month | | | |



I HEREBY CERTIFY THAT THE ABOVE NAMED PERSON IS REGISTERED AS INDICATED ABOVE, UNDER THE PROVISIONS OF THE NATIONAL INTERNAL REVENUE CODE, AS AMENDED.

MAXIMO T. CEBRECUS, JR.
REVENUE DISTRICT OFFICER (signature over printed name)

LURLEEN C. CRISOSTOMO
Chief, Client Support Service

THIS CERTIFICATE MUST BE EXHIBITED CONSPICUOUSLY IN THE PLACE OF BUSINESS

SSS CERTIFICATE OF MEMBERSHIP

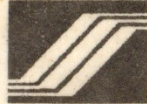

Republic of the Philippines
Social Security System
Quezon City

Certificate of Membership

This is to certify that

JAMAN PRODUCT INC
RM 704 POTAN BLDG
479 JABONEROS ST BINONDO MLA
Employer ID : 03-9052031-3

has been duly registered as a member of the Social Security System. As such all the covered employees and workers thereof are entitled to all the benefits and privileges pertaining to membership in the System pursuant to and in accordance with the provisions of Republic Act 1161 as amended.

Issued this 01 day of July, 2003

Date of Coverage 0603

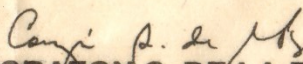
CORAZON S. DE LA PAZ
President & CEO

PHILHEALTH CERTIFICATE OF REGISTRATION



Republic of the Philippines

PHILIPPINE HEALTH INSURANCE CORPORATION

Citystate Center Building, 709 Shaw Boulevard, Oranbo, Pasig City

Certificate of Registration

This is to certify that

JAMAN PRODUCTS INC

(Company/Employer Name)

6 Banahaw St Amparo Subd Sitio Kapre, Nagkaisang Nayon, Quezon City

(Complete Address)

002000008754

(PhilHealth Employer Number)

has been duly registered as a member-employer of the National Health Insurance Program (NHIP).
As such, all employees and workers thereof are entitled to the benefits and privileges appurtenant to NHIP members, pursuant to and in accordance with the provisions of the National Health Insurance Act of 1995 (RA 7875).

Given under the hand and seal of the Philippine Health Insurance Corporation
this 28th day of September year Two Thousand and fifteen

ALEXANDER A. PADILLA

President and CEO

PAG-IBIG REGISTRATION

HQP-PFF-027

EMPLOYER ID NO. 201476020009



Certificate of Employer's Registration

This certifies that

JAMAN PRODUCTS INC.

with principal address at

#6 Banahaw St., Amparo Subd., Sitio Capri,
Nagkaisang Nayon, Novaliches, Quezon City

is registered with the Pag-IBIG Fund.

In witness whereof, the Pag-IBIG Fund hereby issues this Certificate this

17th day of September 2007

X WA.

ACMAD RIZALDY P. MOTI
Chief Executive Officer

IPO REGISTRATION



Certificate of RENEWAL of Registration

Registration No. : 4/2001/00008234
Date of Registration : 28 August 2004
Date of Renewal : 28 August 2014
Term : 10 years (until 28 August 2024)

JAMAN

JAMAN

| | |
|-------------------------------|--|
| Filing Date | : 5 November 2001 |
| Registrant | : JAMAN PRODUCTS, INC. [PH] |
| Registrant's Address | : #6 Banahaw Street, Bgy. Nagkaisang Nayon, Novaliches, Quezon City, Metro Manila, Philippines |
| Class(es) - Goods/Services | : Class 6: Drains, namely, roof drain, floor drain, scupper drain, canopy drain, and all kinds of drains |
| Claim of Color(s) | : None |
| Disclaimer | : None |
| Transliteration / Translation | : None |
| Three-dimensional | : No |
| Claim of Priority | : None |

LENY B. RAZ
Director
Bureau of Trademarks

Document No: 2015/106043

IPO REGISTRATION



Certificate of RENEWAL of Registration

Registration No. : 4/2009/00007855
Date of Registration : 23 September 2010
Date of Renewal : 23 September 2020
Term : 10 years (until 23 September 2030)

JAMAN PRODUCTS, INC.

JAMAN PRODUCTS, INC.

Filing Date : 7 August 2009
Registrant : JAMAN PRODUCTS, INC. [PH]
Registrant's Address : #6 Banahaw St., Amparo Subd., Sitio Capri, Nagkaisang Nayan, Novaliches, Quezon City, Metro Manila, Philippines
Class(es) - Goods/Services : Class 35: Metal fabrication (i.e. buying, distributing, marketing all kinds of goods wholesale and retail)
Claim of Color(s) : none
Disclaimer : products, Inc.
Transliteration / Translation : None
Three-dimensional : No
Claim of Priority : None

LENY B. RAZ
Director
Bureau of Trademarks

Digitally Signed by IPO Philippines
26/10/2020
CRUZITA ALEN R. SALDO

Document No: 2020/199184

IPO REGISTRATION



Certificate of RENEWAL of Registration

Registration No. : 4/2010/00000806
Date of Registration : 29 July 2010
Date of Renewal : 29 July 2020
Term : 10 years (until 29 July 2030)

JPI

JPI

Filing Date : 25 January 2010
Registrant : Jaman Products, Inc. [PH]
Registrant's Address : 6 Banahaw Street Brgy. Nagkaisang Nayon, Novaliches,
Quezon City, Metro Manila, Philippines
Class(es) - Goods/Services : canopy drains all types of drains, manhole, cistern cover,
grease trap, grating cleanouts
Claim of Color(s) : None
Disclaimer : None
Transliteration / Translation : None
Three-dimensional : No
Claim of Priority : None

LENY B. RAZ
Director
Bureau of Trademarks

Digitally Signed by IPO Philippines
24/11/2020
CRUZITA ALEN R. SALDO

Document No: 2020/221338

ON-GOING PROJECTS

ON-GOING PROJECTS 2022

| | | |
|---|---|--|
| <p>Client : Project Location : Sonata Project Nature : Supply of Grease Trap Contract Amount : 900,000.00</p> | <p>Client : Project Location : Sunshine Fort / Project Nature : Supply of drain materials Contract Amount : 2.7M</p> | <p>Client : Project Location : Acacia Escalades Tower Project Nature : Supply of Grease Interceptor Contract Amount : 1.2M</p> |
| <p>Client : Project Location : The Radiance Manila Bay Project Nature : Supply of Grease Trap Contract Amount : 2.8M</p> | <p>Client : Project Location : UST Sta Rosa Laguna Project Nature : Supply of drain materials Contract Amount : 2.5M</p> | <p>Client : Project Location : Lakeshore Drive Davao Park Project Nature : Supply of Grease Trap Contract Amount : 2.9M</p> |
| <p>Client : Project Location : SRP2 Cebu City Project Nature : Supply of drain materials Contract Amount : 204,000.00</p> | <p>Client : Project Location : LRT Depot - Zapote Project Nature : Supply of SS Oil Interceptor Contract Amount : 1.1M</p> | <p>Client : Project Location : Suntrust Solana Project Nature : Supply of Grease Trap Contract Amount : 1.5M</p> |
| <p>Client : Project Location : IMET BPO Tower Project Nature : Supply of Grease Trap Contract Amount : 1.1M</p> | <p>Client : Project Location : Green Tower - 2 Project Nature : Supply of drain materials Contract Amount : 3.2M</p> | <p>Client : Project Location : South Palms Project Nature : Supply of Manhole Cover, Drains Contract Amount : 1.7M</p> |
| <p>Client : Project Location : Jose Lapid Sports Complex Project Nature : Supply of C.I. Concave Grating Contract Amount : 1.7M</p> | <p>Client : Project Location : New Coast Station - Malay Aklan Boreacay Project Nature : Supply of Trench grating cover Contract Amount : 330,000.00</p> | <p>Client : Project Location : Solihya Office Project Nature : Supply of catch basin cover Contract Amount : 366,100.00</p> |
| <p>Client : Project Location : Terraces @ Tradizo Cavite Enclave - C01 Project Nature : Supply of drain materials Contract Amount : 520,000.00</p> | <p>Client : Project Location : NSCR DEPOT BUILDING Project Nature : Supply of manhole cover Contract Amount : 408,000.00</p> | <p>Client : Project Location : Modala Leisure Park Project Nature : Supply of drain materials Contract Amount : 380,000.00</p> |
| <p>Client : Project Location : Waitermart Altaraza - SFDM Project Nature : Supply of Manhole Cover, Drains Contract Amount : 378,000.00</p> | <p>Client : Project Location : FLORIDA BLANCA CONST & DEVT CORP Project Location : UP International Center - Diliman Project Nature : Supply Manhole Cover for sewer system Contract Amount : 260,000.00</p> | <p>Client : Project Location : Dasmariñas Cavite Sports Arena Project Nature : Supply of manhole cover Contract Amount : 150,500.00</p> |
| <p>Client : Project Location : 1129 Aurelia Residences Project Nature : Supply Manhole Cover for sewer system Contract Amount : 180,000.00</p> | <p>Client : Project Location : Golf Residences Ph-3 Project Nature : Supply Manhole Cover for sewer system Contract Amount : 140,000.00</p> | <p>Client : Project Location : Belmont Hotel Mactan Project Nature : Supply of gratings Contract Amount : 180,000.00</p> |

On-going projects 2022

ON-GOING PROJECTS

ON-GOING PROJECTS 2022

| | | | | | |
|--|---|---|--|--|--|
| <p>Client : Project Location : Avida Towers - Mandaluyong Project Nature : Supply of drain materials Contract Amount : 327,400.00</p> | <p>BOS BASED ON SCIENTIA INC</p> | <p>Client : Project Location : Anton By Rockwell Project Nature : Supply of drain materials Contract Amount : 145,800.00</p> | <p>CITIAIRE INDUSTRIAL SERVICES</p> | <p>Client : Project Location : GSC PH-1 Project Nature : Supply of drain materials Contract Amount : 155,000.00</p> | <p>CITIAIRE INDUSTRIAL SERVICES</p> |
| <p>Client : Project Location : Mango Tree Project Nature : Supply of Trench Grating Cover Contract Amount : 260,000.00</p> | <p>METROSTONERICH CONSTRUCTION</p> | <p>Client : Project Location : Connor Project Nature : Supply of drain materials Contract Amount : 1.5M</p> | <p>CITIAIRE INDUSTRIAL SERVICES</p> | <p>Client : Project Location : Grand Hyatt Project Nature : Supply of Grease Trap Contract Amount : 144,000.00</p> | <p>CITIAIRE INDUSTRIAL SERVICES</p> |
| <p>Client : Project Location : 110 Benavidez Makati City Project Nature : Supply of Trench Grating Cover Contract Amount : 520,000.00</p> | <p>METROSTONERICH CONSTRUCTION</p> | <p>Client : Project Location : Cebu Cyberzone Project Nature : Supply of drain materials Contract Amount : 150,000.00</p> | <p>CITIAIRE INDUSTRIAL SERVICES</p> | <p>Client : Project Location : Batangas City WD - Project Nature : Supply Manhole Cover Contract Amount : 120,000.00</p> | <p>MGS CONSTRUCTION INC</p> |
| <p>Client : Project Location : Holywood Suites Project Nature : Supply of Grease Trap Contract Amount : 600,000.00</p> | <p>METROSTONERICH CONSTRUCTION</p> | <p>Client : Project Location : Makati Commerce Project Nature : Supply of Grease Trap Contract Amount : 127,500.00</p> | <p>KALAYAAN ENGINEERING CO ING</p> | <p>Client : Project Location : SAVYA Finance Center Project Nature : Supply of drain materials Contract Amount : 430,000.00</p> | <p>KALAYAAN ENGINEERING CO ING</p> |
| <p>Client : Project Location : JCLDS Alabang Temple Project Nature : Supply of Steel Ladder Contract Amount : 151,200.00</p> | <p>SHINRYO PHILIPPINES CO. INC</p> | <p>Client : Project Location : Analog Project Nature : Supply of drain materials Contract Amount : 350,000.00</p> | <p>EEI CORPORATION</p> | <p>Client : Project Location : H.I. Corporate Project Nature : Supply of drain materials Contract Amount : 350,000.00</p> | <p>EEI CORPORATION</p> |

On-going projects 2022

COMPLETED PROJECTS



COMPLETED PROJECTS 2019 - 2020

| | | | | | |
|---|---|---|---|---|---|
| Client : Project Location : Contract Amount : | MAKATI DEVELOPMENT CORPORATIC AVIDA TOWERS T2 PROJ 997,350 | Client : Project Location : Contract Amount : | MAKATI DEVELOPMENT CORPORATION BGC TAGUIG 61,154 | Client : Project Location : Contract Amount : | MAKATI DEVELOPMENT CORPORATION AYALA MALL VERMOSA 101,775 |
| Client : Project Location : Contract Amount : | MAKATI DEVELOPMENT CORPORATIC AVIDA TOWERS MONTANE 15,150 | Client : Project Location : Contract Amount : | MAKATI DEVELOPMENT CORPORATION AVIDA TOWERS PRIME TAFT 9,636 | Client : Project Location : Contract Amount : | MAKATI DEVELOPMENT CORPORATION NIRWANA CX RAWLAND 43,200 |
| Client : Project Location : Contract Amount : | MDC BUILD PLUS CAPITOL CENTRAL MALL 175200 | Client : Project Location : Contract Amount : | MAKATI DEVELOPMENT CORPORATION SEDA 177,750 | Client : Project Location : Contract Amount : | MAKATI DEVELOPMENT CORPORATION SEDA BGC 248,935 |
| Client : Project Location : Contract Amount : | EMPIRE EASTLAND HOLDINGS INC Rochester Park Tower F 1,075,095.00 | Client : Project Location : Contract Amount : | DAMATECH CONSTRUCTION SONATA Hotel & Residences 1,920,195.95 | Client : Project Location : Contract Amount : | PROPERTY CO OF FRIENDS INC Lancaster Estates 697,900.00 |
| Client : Project Location : Contract Amount : | IPM CONST & DEVT CORP UST 3,655,600.00 | Client : Project Location : Contract Amount : | JOUBERT CONSTRUCTION Shore 2 Residences 4,497,040.00 | Client : Project Location : Contract Amount : | RHOLEAN BUILDERS INC Parlinks 596,736.00 |
| Client : Project Location : Contract Amount : | KALAYAAN ENGINEERING CO, INC The Alcoves 1,406,475.00 | Client : Project Location : Contract Amount : | JOUBERT CONSTRUCTION Trion Tower 3 922,380.00 | Client : Project Location : Contract Amount : | DDT KONSTRACT INC Bayshore Residential Resort P2 228,000.00 |
| Client : Project Location : Contract Amount : | AGCHEM CONSTRUCTION Manila Bay Lot 1 765,000.00 | Client : Project Location : Contract Amount : | SKYNET CONST & ENGG SERVICES Fame Residences 2,500,198.00 | Client : Project Location : Contract Amount : | DDT KONSTRACT INC MBP Office 1,150,000.00 |
| Client : Project Location : Contract Amount : | CREATIVE PROVERBS ENT Magic Mall San Carlos Pangasinan 526,000.00 | Client : Project Location : Contract Amount : | SKYNET CONST & ENGG SERVICES Fame Residences PH2 Tower 3&4 3,922,488.00 | Client : Project Location : Contract Amount : | DDT KONSTRACT INC West End Square 1,271039.99 |
| Client : Project Location : Contract Amount : | DAMATECH CONSTRUCTION SONATA Hotel & Residences 883,000.00 | Client : Project Location : Contract Amount : | DMCI PROJECT DEVELOPERS INC Mulberry Place MLP 260,000.00 | Client : Project Location : Contract Amount : | HILMARCS CONSTRUCTION Proposed USP Hospital 235,000.00 |
| Client : Project Location : Contract Amount : | TMB CONSTRUCTION S&R New Manila 536,800.00 | Client : Project Location : Contract Amount : | MONOLITH CONSTRUCTION One Paseo 730,700.61 | Client : Project Location : Contract Amount : | FREY-FIL CORPORATION Athlete's Vill 5 800,000.00 |
| Client : Project Location : Contract Amount : | COMMUNITIES DAVAO INC Bradford Northpoint 650,025.00 | Client : Project Location : Contract Amount : | ASUKI DEVT & CONST MANAGEMENT CDO Module 2 BPO 190,630.00 | Client : Project Location : Contract Amount : | MEGAWORLD CORP One Paseo 105,000.00 |

COMPLETED PROJECTS

| | | | | | |
|---|---|---|---|---|---|
| Client : Project Location : Contract Amount : | CENTURY LIMITLESS Commonwealth 620,000.00 | Client : Project Location : Contract Amount : | ALLLINKS WM Subic 377,400.00 | Client : Project Location : Contract Amount : | PARAVISIBLE BUILDERS INC SM Silangan Warehouse 216,000.00 |
| Client : Project Location : Contract Amount : | COMMUNITIES NEGROS INC Negros Condo Homes Bacolod 269,325.00 | Client : Project Location : Contract Amount : | TRIPLEWELL CONST CORP The Flats 1,350,000.00 | Client : Project Location : Contract Amount : | PHIL REALTY & HOLDINGS CORP SkyVillas 315,000.00 |
| Client : Project Location : Contract Amount : | EM CUERPO HLURB BUILDING 440,000.00 | Client : Project Location : Contract Amount : | TRIPLEWELL CONST CORP Ayala Mall Vermosa Bldg C 260,000.00 | Client : Project Location : Contract Amount : | PARAVISIBLE BUILDERS INC Cheerful Homes Mabalacat 412,000.00 |
| Client : Project Location : Contract Amount : | MAXIPRO DEVELOPMENT CORP Philam Homes 105,000.00 | Client : Project Location : Contract Amount : | BUILDING BEAVER 5-Storey Basement Commercial 90,000.00 | Client : Project Location : Contract Amount : | STA LUCIA LAND INC Sta Lucia BPO 125,800.00 |
| Client : Project Location : Contract Amount : | MGS North Molino STP 229,500.00 | Client : Project Location : Contract Amount : | BETA ELECTRIC CORPORATION Taguig 958,325.80 | Client : Project Location : Contract Amount : | NOBLELAND VENTURES INC. The Exchange Regency 155,000.00 |
| Client : Project Location : Contract Amount : | SKYAIRE AIRCONDITIONING CENTER CORP AMA Tower 3,700,000.00 | Client : Project Location : Contract Amount : | DMCI PROJECT DEVELOPERS INC Calathea Place 120,000.00 | Client : Project Location : Contract Amount : | EM CUERPO HLURB BUILDING 440,000.00 |
| Client : Project Location : Contract Amount : | COMMUNITIES DAVAO INC Bradford Northpoint 650,025.00 | Client : Project Location : Contract Amount : | SUNTRUST PROPERTIES INC Solana Parking 102,000.00 | Client : Project Location : Contract Amount : | CENTURY LIMITLESS Commonwealth 620,000.00 |
| Client : Project Location : Contract Amount : | COMMUNITIES NEGROS INC Negros Condo Homes Bacolod 269,325.00 | Client : Project Location : Contract Amount : | METROSTONERICH CORP Government Housing 2,800,000.00 | Client : Project Location : Contract Amount : | COMMUNITIES BATANGAS, INC Batangas 275,000.00 |

**FLOOR DRAIN ADJUSTABLE TYPE
MODEL : JPI - 100-1 B**

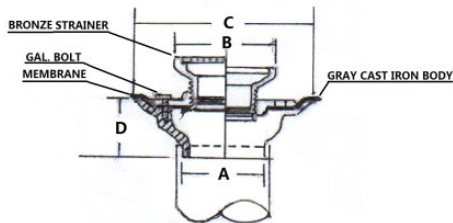

| PIPE SIZE | STRAINER SIZE | | | | OPEN AREA IN INCH. | |
|-----------|---------------|---------|-----------------|-------|-----------------------|----|
| | A | B X B | C | D | | |
| 2" | 51 mm | 4" x 4" | 102 mm x 102 mm | 37 mm | 88 mm | 5 |
| 3" | 76 mm | 5" x 5" | 127 mm x 127 mm | 42 mm | 88 mm | 7 |
| 4" | 102 mm | 6" x 6" | 152 mm x 152 mm | 44 mm | 88 mm | 12 |

**FLOOR DRAIN ADJUSTABLE TYPE
MODEL : JPI - 100-2**

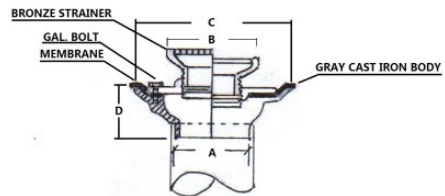

| PIPE SIZE | STRAINER SIZE | | | | OPEN AREA IN INCH. | |
|-----------|---------------|---------|-----------------|-------|-----------------------|----|
| | A | B X B | C | D | | |
| 2" | 51 mm | 4" X 4" | 102 mm X 102 mm | 37 mm | 88 mm | 5 |
| 3" | 76 mm | 5" X 5" | 127 mm X 127 mm | 42 mm | 88 mm | 7 |
| 4" | 102 mm | 6" X 6" | 152 mm X 152 mm | 44 mm | 88 mm | 12 |

BRASS FLOOR STRAINER WITH FUNNEL WITH C.I. HOUSING

**FLOOR DRAIN ADJUSTABLE TYPE
MODEL : JPI - 100-3**

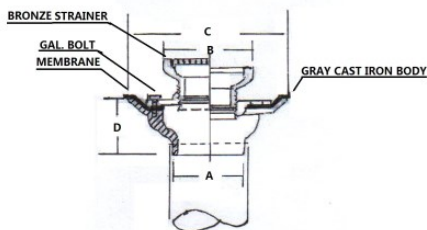

| PIPE SIZE | STRAINER SIZE | | | | OPEN AREA IN INCH. | |
|-----------|---------------|---------|-----------------|-------|-----------------------|----|
| | A | B X B | C | D | | |
| 2" | 51 mm | 4" X 4" | 102 mm X 102 mm | 37 mm | 88 mm | 5 |
| 3" | 76 mm | 5" X 5" | 127 mm X 127 mm | 42 mm | 88 mm | 7 |
| 4" | 102 mm | 6" X 6" | 152 mm X 152 mm | 44 mm | 88 mm | 12 |

BRASS FLOOR STRAINER SQUARE OPENING WITH C.I. HOUSING

**FLOOR DRAIN ADJUSTABLE TYPE
MODEL : JPI - 100-4**

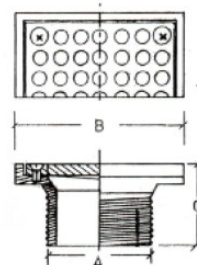

| PIPE SIZE | STRAINER SIZE | | | | OPEN AREA IN INCH. | |
|-----------|---------------|---------|-----------------|-------|-----------------------|----|
| | A | B X B | C | D | | |
| 2" | 51 mm | 4" X 4" | 102 mm X 102 mm | 37 mm | 88 mm | 5 |
| 3" | 76 mm | 5" X 5" | 127 mm X 127 mm | 42 mm | 88 mm | 7 |
| 4" | 102 mm | 6" X 6" | 152 mm X 152 mm | 44 mm | 88 mm | 12 |

**BRASS FLOOR DRAIN ADJUSTABLE TYPE
WITH CAST IRON HOUSING**

JAMAN® is a registered trademark of JAMAN PRODUCTS INC for all kinds of drains under REG # 4/2001/00008234 and all kinds of manhole, grease traps, cleanouts, gratings, roof basket strainers under REG# 4/2015/00010854

**FLOOR DRAIN ADJUSTABLE TYPE
MODEL : JPI - 100-5**

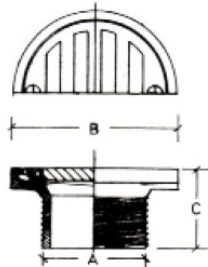

| PIPE SIZE | STRAINER SIZE | | | | OPEN AREA 1 IN INCH |
|------------------|---------------|---------------|-------|-------|------------------------|
| | A | B | C | D | |
| 2" 51 mm ϕ | 4" ϕ | 102 mm ϕ | 37 mm | 40 mm | 5 |
| 3" 78 mm ϕ | 5" ϕ | 127 mm ϕ | 42 mm | 45 mm | 7 |
| 4" 102 mm ϕ | 6" ϕ | 152 mm ϕ | 44 mm | 65 mm | 12 |

**BRASS FLOOR DRAIN ADJUSTABLE TYPE
WITH CAST IRON HOUSING**

**FLOOR DRAIN ADJUSTABLE TYPE
MODEL : JPI - 100 - 6**

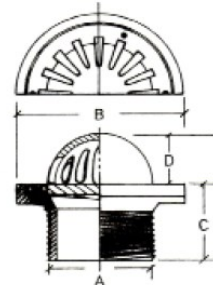

| PIPE SIZE | STRAINER SIZE | | | | OPEN AREA 1 IN INCH |
|------------------|---------------|---------------|-------|-------|------------------------|
| | A | B | C | D | |
| 2" 51 mm ϕ | 4" ϕ | 102 mm ϕ | 37 mm | 40 mm | 5 |
| 3" 78 mm ϕ | 5" ϕ | 127 mm ϕ | 42 mm | 45 mm | 7 |
| 4" 102 mm ϕ | 6" ϕ | 152 mm ϕ | 44 mm | 65 mm | 12 |

**BRASS FLOOR DRAIN ADJUSTABLE TYPE
WITH CAST IRON HOUSING**

**FLOOR DRAIN ADJUSTABLE TYPE
MODEL : JPI - 100 - 7**

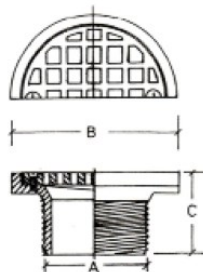

| PIPE SIZE | STRAINER SIZE | | | | OPEN AREA 1 IN INCH |
|------------------|---------------|---------------|-------|-------|------------------------|
| | A | B | C | D | |
| 2" 51 mm ϕ | 4" ϕ | 102 mm ϕ | 37 mm | 40 mm | 5 |
| 3" 78 mm ϕ | 5" ϕ | 127 mm ϕ | 42 mm | 45 mm | 7 |
| 4" 102 mm ϕ | 6" ϕ | 152 mm ϕ | 44 mm | 65 mm | 12 |

**BRASS FLOOR DRAIN ADJUSTABLE TYPE
WITH CAST IRON HOUSING**

**FLOOR DRAIN ADJUSTABLE TYPE
MODEL : JPI - 100 - 8**

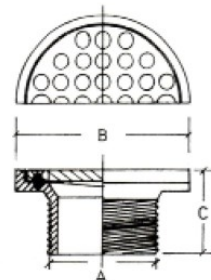

| PIPE SIZE | STRAINER SIZE | | | | OPEN AREA 1 IN INCH |
|------------------|---------------|---------------|-------|-------|------------------------|
| | A | B | C | D | |
| 2" 51 mm ϕ | 4" ϕ | 102 mm ϕ | 37 mm | 40 mm | 5 |
| 3" 78 mm ϕ | 5" ϕ | 127 mm ϕ | 42 mm | 45 mm | 7 |
| 4" 102 mm ϕ | 6" ϕ | 152 mm ϕ | 44 mm | 65 mm | 12 |

**BRASS FLOOR DRAIN ADJUSTABLE TYPE
WITH CAST IRON HOUSING**

JAMAN® is a registered trademark of JAMAN PRODUCTS INC for all kinds of drains under REG # 4/2001/00008234 and all kinds of manhole, grease traps, cleanouts, gratings, roof basket strainers under REG# 4/2015/00010854

STAINLESS STEEL CONCEALED FLOOR DRAIN

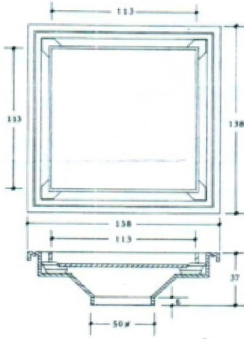

This floor drain intends to appear obscure in tiles so as not to ruin the construction and the wholesomeness of the conceived design. Our product bares intricate details that are well observed and managed. This design's drain is sheltered by around 10mm thick tile. A spout is found on the frame to mount in the PVC pipe with 50mm diameter.

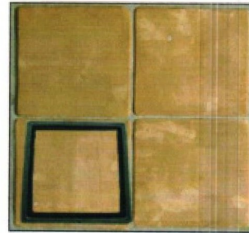
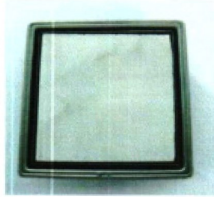

FLOOR DRAIN MODEL : JPI - 101

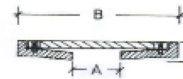

| OPEN AREA IN INCH. | PIPE SIZE | | STRAINER SIZE | | |
|-----------------------|-----------|--------|---------------|---------------------|-------|
| | A | | B X B | C | |
| 5 | 2" | 51 mm | 4" x 4" | 102 mm ² | 12 mm |
| 7 | 3" | 76 mm | 5" x 5" | 127 mm ² | 12 mm |
| 12 | 4" | 102 mm | 6" x 6" | 152 mm ² | 12 mm |

BRASS FLOOR AND SHOWER STRAINER WITH PERFORATED OPENINGS
SQUARE TYPE

FLOOR DRAIN MODEL : JPI - 102

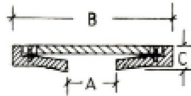
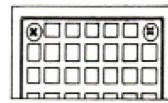

| OPEN AREA IN INCH. | PIPE SIZE | | STRAINER SIZE | | |
|-----------------------|-----------|--------|---------------|---------------------|-------|
| | A | | B X B | C | |
| 5 | 2" | 51 mm | 4" X 4" | 102 mm ² | 12 mm |
| 7 | 3" | 76 mm | 5" X 5" | 127 mm ² | 12 mm |
| 12 | 4" | 102 mm | 6" X 6" | 152 mm ² | 12 mm |

BRASS FLOOR AND SHOWER STRAINER WITH SQUARE
OPENINGS, SQUARE TYPE

FLOOR DRAIN MODEL : JPI - 103

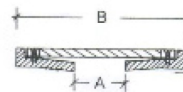
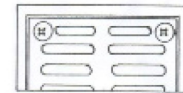
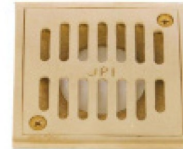

| OPEN AREA IN INCH. | PIPE SIZE | | STRAINER SIZE | | |
|-----------------------|-----------|--------|---------------|---------------------|-------|
| | A | | B X B | C | |
| 5 | 2" | 51 mm | 4" x 4" | 102 mm ² | 12 mm |
| 7 | 3" | 76 mm | 5" x 5" | 127 mm ² | 12 mm |
| 12 | 4" | 102 mm | 6" x 6" | 152 mm ² | 12 mm |

BRASS FLOOR AND SHOWER STRAINER WITH SLOTTED OPENINGS
SQUARE TYPE

JAMAN® is a registered trademark of JAMAN PRODUCTS INC for all kinds of drains under REG # 4/2001/0008234 and all kinds of manhole, grease traps, cleanouts, gratings, roof basket strainers under REG# 4/2015/00010854

FLOOR DRAIN MODEL : JPI - 104

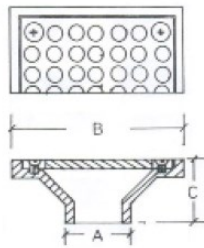

| OPEN AREA IN INCH. | PIPE SIZE | | STRAINER SIZE | | |
|-----------------------|-----------|--------|---------------|---------------------|-------|
| | A | | B X B | | C |
| 5 | 2" | 51 mm | 4" x 4" | 102 mm ² | 29 mm |
| 7 | 3" | 76 mm | 5" x 5" | 127 mm ² | 29 mm |
| 12 | 4" | 102 mm | 6" x 6" | 152 mm ² | 29 mm |

BRASS FLOOR AND SHOWER STRAINER WITH PERFORATED OPENINGS
SQUARE TYPE

PURE STAINLESS FLOOR DRAIN MODEL : JPI - 105 SS

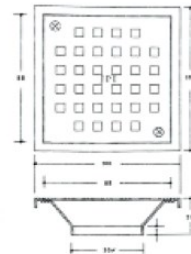

| OPEN AREA IN INCH. | PIPE SIZE | | STRAINER SIZE | | |
|-----------------------|-----------|-------|---------------|---------------------|-------|
| | A | | B X B | | C |
| 5 | 2" | 51 mm | 4" x 4" | 102 mm ² | 26 mm |

PURE STAINLESS 304 FLOOR AND SHOWER STRAINER
WITH SQUARE OPENING SQUARE TYPE

FLOOR DRAIN MODEL : JPI - 105

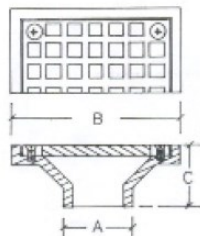

| OPEN AREA IN INCH. | PIPE SIZE | | STRAINER SIZE | | |
|-----------------------|-----------|--------|---------------|---------------------|-------|
| | A | | B X B | | C |
| 5 | 2" | 51 mm | 4" x 4" | 102 mm ² | 29 mm |
| 7 | 3" | 76 mm | 5" x 5" | 127 mm ² | 29 mm |
| 12 | 4" | 102 mm | 6" x 6" | 152 mm ² | 29 mm |

BRASS FLOOR AND SHOWER STRAINER WITH SQUARE OPENINGS
SQUARE TYPE

FLOOR DRAIN MODEL : JPI - 106 S

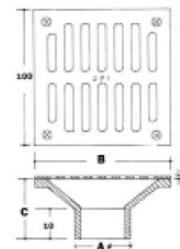

| OPEN AREA IN INCH. | PIPE SIZE | | STRAINER SIZE | | |
|-----------------------|-----------|--------|---------------|---------------------|-------|
| | A | | B X B | | C |
| 5 | 2" | 51 mm | 4" x 4" | 102 mm ² | 25 mm |
| 7 | 3" | 76 mm | 5" x 5" | 127 mm ² | 25 mm |
| 12 | 4" | 102 mm | 6" x 6" | 152 mm ² | 25 mm |

STAINLESS COVER WITH CI BASE WITH SLOTTED OPENINGS
SQUARE TYPE

JAMAN® is a registered trademark of JAMAN PRODUCTS INC for all kinds of drains under REG # 4/2001/00008234 and all kinds of manhole, grease traps, cleanouts, gratings, roof basket strainers under REG# 4/2015/00010854

FLOOR DRAIN MODEL : JPI - 106 B

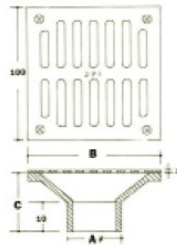

| OPEN AREA IN INCH. | PIPE SIZE | | STRAINER SIZE | | |
|-----------------------|-----------|--------|---------------|---------------------|-------|
| | A | | B X B | C | |
| 5 | 2" | 51 mm | 4" x 4" | 102 mm ² | 25 mm |
| 7 | 3" | 76 mm | 5" x 5" | 127 mm ² | 25 mm |
| 12 | 4" | 102 mm | 6" x 6" | 152 mm ² | 25 mm |

BRASS COVER WITH CI BASE WITH SLOTTED OPENINGS
SQUARE TYPE

PURE STAINLESS FLOOR DRAIN MODEL : JPI - 106 SS

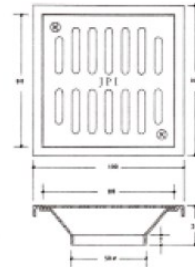

| OPEN AREA IN INCH. | PIPE SIZE | | STRAINER SIZE | | |
|-----------------------|-----------|-------|---------------|---------------------|-------|
| | A | | B X B | C | |
| 5 | 2" | 51 mm | 4" x 4" | 102 mm ² | 26 mm |

PURE STAINLESS 304 FLOOR AND SHOWER STRAINER
WITH SLOTTED OPENING SQUARE TYPE

FLOOR DRAIN MODEL : JPI - 106 WH

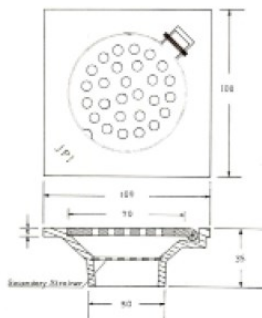

| OPEN AREA IN INCH. | PIPE SIZE | | STRAINER SIZE | | |
|-----------------------|-----------|-------|---------------|---------------------|-------|
| | A | | B X B | C | |
| 5 | 2" | 51 mm | 4" x 4" | 102 mm ² | 35 mm |

BRASS FLOOR AND WASHING MACHINE STRAINER WITH HINGE,
PERFORATED OPENINGS, SQUARE TYPE

FLOOR DRAIN MODEL : JPI - 106

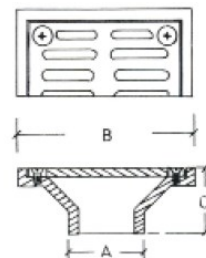
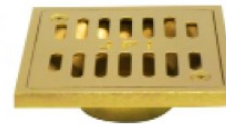

| OPEN AREA IN INCH. | PIPE SIZE | | STRAINER SIZE | | |
|-----------------------|-----------|--------|---------------|---------------------|-------|
| | A | | B X B | C | |
| 5 | 2" | 51 mm | 4" x 4" | 102 mm ² | 29 mm |
| 7 | 3" | 76 mm | 5" x 5" | 127 mm ² | 29 mm |
| 12 | 4" | 102 mm | 6" x 6" | 152 mm ² | 29 mm |

BRASS FLOOR AND SHOWER STRAINER WITH
SLOTTED OPENINGS, SQUARE TYPE

JAMAN® is a registered trademark of JAMAN PRODUCTS INC for all kinds of drains under REG # 4/2001/00008234 and all kinds of manhole, grease traps, cleanouts, gratings, roof basket strainers under REG# 4/2015/00010854

FLOOR DRAIN MODEL : JPI - 107

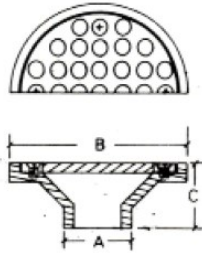

| OPEN AREA IN INCH. | PIPE SIZE | | STRAINER SIZE | | |
|-----------------------|-----------|--------|---------------|---------------|-------|
| | A | | B | C | |
| 5 | 2" | 51 mm | 4" ϕ | 102 mm ϕ | 29 mm |
| 7 | 3" | 76 mm | 5" ϕ | 127 mm ϕ | 29 mm |
| 12 | 4" | 102 mm | 6" ϕ | 152 mm ϕ | 29 mm |

BRASS FLOOR AND SHOWER STRAINER WITH PERFORATED OPENINGS, ROUND TYPE

FLOOR DRAIN MODEL : JPI - 108

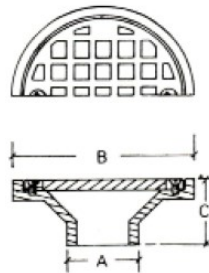

| OPEN AREA IN INCH. | PIPE SIZE | | STRAINER SIZE | | |
|-----------------------|-----------|--------|---------------|---------------|-------|
| | A | | B | C | |
| 5 | 2" | 51 mm | 4" ϕ | 102 mm ϕ | 29 mm |
| 7 | 3" | 76 mm | 5" ϕ | 127 mm ϕ | 29 mm |
| 12 | 4" | 102 mm | 6" ϕ | 152 mm ϕ | 29 mm |

BRASS FLOOR AND SHOWER STRAINER WITH SQUARE OPENINGS, ROUND TYPE

FLOOR DRAIN MODEL : JPI - 109

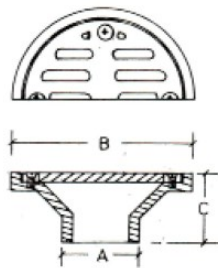

| OPEN AREA IN INCH. | PIPE SIZE | | STRAINER SIZE | | |
|-----------------------|-----------|--------|---------------|---------------|-------|
| | A | | B | C | |
| 5 | 2" | 51 mm | 4" ϕ | 102 mm ϕ | 29 mm |
| 7 | 3" | 76 mm | 5" ϕ | 127 mm ϕ | 29 mm |
| 12 | 4" | 102 mm | 6" ϕ | 152 mm ϕ | 29 mm |

BRASS FLOOR AND SHOWER STRAINER WITH SLOTTED OPENINGS ROUND TYPE

FUNNEL DRAIN MODEL : JPI - 112

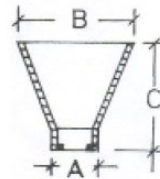

| PIPE SIZE | | STRAINER SIZE | | |
|-----------|-------|---------------|---------------|-------|
| A | | B | C | |
| 2" | 51 mm | 4" ϕ | 102 mm ϕ | 90 mm |

MATERIALS : ALL BRASS

JAMAN® is a registered trademark of JAMAN PRODUCTS INC for all kinds of drains under REG # 4/2001/00008234 and all kinds of manhole, grease traps, cleanouts, gratings, roof basket strainers under REG# 4/2015/00010854

FLOOR DRAIN W/ FUNNEL MODEL : JPI - 113

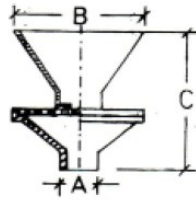

| PIPE SIZE A | STRAINER SIZE | | | OPEN AREA IN INCH | |
|----------------|---------------|-----------|--------------|-------------------------|----|
| | B | C | D | | |
| 2" | 51mm | 4" ϕ | 102mm ϕ | 119mm | 5 |
| 3" | 76mm | 5" ϕ | 127mm ϕ | 119mm | 7 |
| 4" | 102mm | 6" ϕ | 152mm ϕ | 119mm | 12 |

ALL BRASS FUNNEL DRAIN WITH STRAINER

FLOOR CLEAN OUT MODEL : JPI - 114

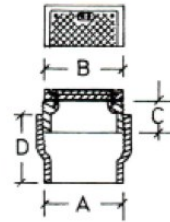

| PIPE SIZE A | ACCESS COVER TOP | | C.I. HOUSING | | |
|----------------|------------------|---------|-----------------|-------|--------|
| | B | C | D | E | |
| 2" | 51 mm | 2" X 2" | 51 mm x 51 mm | 42 mm | 70 mm |
| 3" | 76 mm | 3" X 3" | 76 mm x 76 mm | 43 mm | 76 mm |
| 4" | 102 mm | 4" X 4" | 102 mm x 102 mm | 44 mm | 100 mm |

GRAY CAST IRON BODY WITH SQUARE BRASS TOP, ADJUSTABLE TYPE

FLOOR CLEAN OUT MODEL : JPI - 115

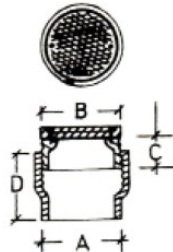

| PIPE SIZE A | ACCESS COVER TOP | | C.I. HOUSING | | |
|----------------|------------------|-----------|--------------|-------|--------|
| | B | C | D | E | |
| 2" | 51 mm | 2" ϕ | 51 mm | 42 mm | 70 mm |
| 3" | 76 mm | 3" ϕ | 76 mm | 43 mm | 76 mm |
| 4" | 102 mm | 4" ϕ | 102 mm | 44 mm | 100 mm |

GRAY CAST IRON BODY WITH ROUND BRASS TOP, ADJUSTABLE TYPE

ROOF DRAIN MODEL : JPI - 116

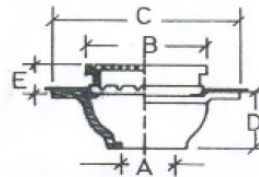

| PIPE SIZE A | DIMENSIONS IN MM | | | | OPEN AREA IN INCH | |
|----------------|------------------|-----|-----|----|----------------------|----|
| | B | C | D | E | | |
| 2" | 51 mm | 210 | 260 | 75 | 25 | 12 |
| 3" | 76 mm | 210 | 260 | 75 | 25 | 12 |
| 4" | 102 mm | 210 | 260 | 75 | 25 | 12 |

GRAY CAST IRON BODY WITH INTEGRAL CLAMPING COLLAR, BRASS LOOSE SET GRATE WITH FRAME, FLAT TYPE

JAMAN® is a registered trademark of JAMAN PRODUCTS INC for all kinds of drains under REG # 4/2001/00008234 and all kinds of manhole, grease traps, cleanouts, gratings, roof basket strainers under REG# 4/2015/00010854

STAINLESS BASKET STRAINER MODEL : JPI - 117

AREA DRAIN MODEL : JPI - 118



| PIPE SIZE | DIMENSIONS IN MM | | | |
|-----------|------------------|-----|-----|----|
| | A | B | C | D |
| 2" | 51 mm | 75 | 51 | 50 |
| 3" | 76 mm | 100 | 76 | 50 |
| 4" | 102 mm | 125 | 102 | 50 |
| 6" | 152 mm | 200 | 152 | 70 |

MATERIALS : STAINLESS STEEL 304

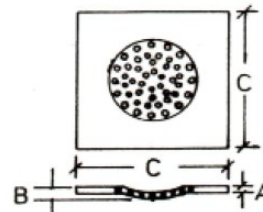
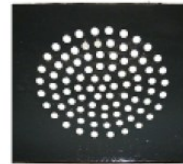

| INCH. | MM | A | B |
|---------|-----------|----|----|
| 6 X 6 | 152 X 152 | 5 | 12 |
| 8 X 8 | 203 X 203 | 5 | 15 |
| 10 X 10 | 254 X 254 | 5 | 20 |
| 12 X 12 | 305 X 305 | 6 | 25 |
| 14 X 14 | 356 X 356 | 10 | 35 |

MATERIAL : GRAY CAST IRON OR BRASS.

CATCH BASIN MODEL : JPI - 119

FLOOR DRAIN TRAP STRAINER MODEL : JPI - 120

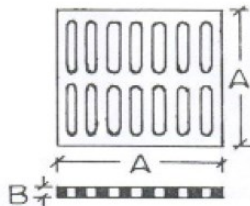

| MODEL NUMBER | DIMENSIONS IN MM | | OPEN AREA IN INCH | |
|--------------|------------------|-----------|-------------------|----|
| | A | B | C | D |
| 119 - A | 8" X 8" | 203 X 203 | 15 | 26 |
| 119 - B | 10" X 10" | 254 X 254 | 20 | 38 |
| 119 - C | 12" X 12" | 305 X 305 | 25 | 50 |
| 119 - D | 14" X 14" | 356 X 356 | 27 | 65 |

MATERIALS : ALL GRAY CAST IRON

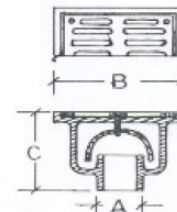

| PIPE SIZE | DIMENSIONS IN MM | | OPEN AREA IN INCH | | |
|-----------|------------------|---------|-------------------|----|----|
| | A | B X B | C | D | |
| 2" | 51 mm | 4" X 4" | 102 mm x 102 mm | 70 | 5 |
| 3" | 76 mm | 5" X 5" | 127 mm x 127 mm | 80 | 7 |
| 4" | 102 mm | 6" X 6" | 152 mm x 152 mm | 90 | 12 |

MATERIALS : ALL BRASS

JAMAN® is a registered trademark of JAMAN PRODUCTS INC for all kinds of drains under REG # 4/2001/00008234 and all kinds of manhole, grease traps, cleanouts, gratings, roof basket strainers under REG# 4/2015/00010854

BACK WATER VALVE MODEL : JPI - 121

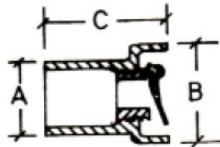

| PIPE SIZE A | DIMENSION IN MM | | |
|----------------|-----------------|-----|-----|
| | B | C | |
| 3" | 76 mm | 178 | 127 |
| 4" | 102 mm | 178 | 127 |
| 6" | 152 mm | 260 | 135 |
| 8" | 203 mm | 280 | 140 |
| 10" | 254 mm | 355 | 178 |

GRAY CAST IRON HOUSING BACK WATER VALVE WITH BRASS COVER, FLAPPER TYPE

GUTTER DRAIN MODEL : JPI - 122

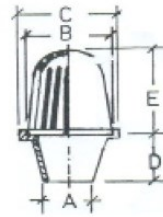

| PIPE SIZE A | DIMENSIONS IN MM | | | | OPEN AREA IN INCH | |
|----------------|------------------|-----|-----|----|----------------------|----|
| | B | C | D | E | | |
| 2" | 51 mm | 127 | 137 | 50 | 128 | 20 |
| 3" | 76 mm | 127 | 137 | 50 | 128 | 20 |
| 4" | 102 mm | 127 | 137 | 50 | 128 | 20 |

GRAY CAST IRON BODY, BRASS DOME 128 mm HIGH, FLASHING RING INTEGRAL WITH GRAVEL STOP

ROOF DRAIN MODEL : JPI - 123

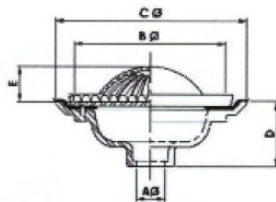

| PIPE SIZE A | DIMENSIONS IN MM | | | | OPEN AREA IN INCH | |
|----------------|------------------|-----|-----|-----|----------------------|-----|
| | B | C | D | E | | |
| 4" | 102 mm | 240 | 297 | 134 | 109 | 70 |
| 6" | 152 mm | 240 | 297 | 134 | 109 | 70 |
| 8" | 203 mm | 330 | 374 | 134 | 109 | 110 |
| 10" | 254 mm | 330 | 374 | 134 | 109 | 110 |

GRAY CAST IRON BODY, BRASS DOME AND FLASHING RING INTEGRAL WITH GRAVEL STOP.

ROOF DRAIN MODEL : JPI - 124

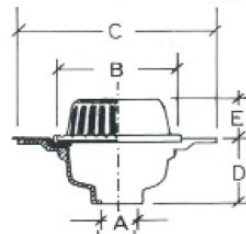

| PIPE SIZE A | DIMENSIONS IN MM | | | | OPEN AREA IN INCH | |
|----------------|------------------|-----|-----|-----|----------------------|----|
| | B | C | D | E | | |
| 2" | 51 mm | 192 | 260 | 75 | 85 | 41 |
| 3" | 76 mm | 192 | 260 | 75 | 85 | 41 |
| 4" | 102 mm | 192 | 260 | 75 | 85 | 41 |
| 6" | 152 mm | 192 | 280 | 100 | 85 | 41 |

GRAY CAST IRON BODY, BRASS DOME 85 mm HIGH, FLASHING RING INTEGRAL WITH GRAVEL STOP

JAMAN® is a registered trademark of JAMAN PRODUCTS INC for all kinds of drains under REG # 4/2001/00008234 and all kinds of manhole, grease traps, cleanouts, gratings, roof basket strainers under REG# 4/2015/00010854

ROOF DRAIN MODEL : JPI - 125

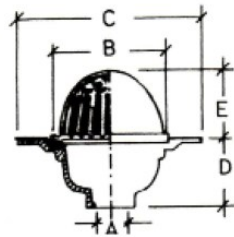

| PIPE SIZE | DIMENSIONS IN MM | | | | | OPEN AREA IN INCH |
|-----------|------------------|-----|-----|-----|-----|-------------------|
| | A | B | C | D | E | |
| 2" | 51 mm | 195 | 260 | 75 | 140 | 4.5 |
| 3" | 76 mm | 195 | 260 | 75 | 140 | 4.5 |
| 4" | 102 mm | 195 | 260 | 75 | 140 | 4.5 |
| 6" | 152 mm | 195 | 260 | 100 | 140 | 4.5 |

GRAY CAST IRON BODY, BRASS DOME 140 mm HIGH, FLASHING RING INTEGRAL WITH GRAVEL STOP.

ROOF DRAIN MODEL : JPI - 126

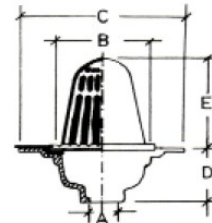

| PIPE SIZE | DIMENSIONS IN MM | | | | | OPEN AREA IN INCH |
|-----------|------------------|-----|-----|-----|-----|-------------------|
| | A | B | C | D | E | |
| 2" | 51 mm | 200 | 285 | 100 | 200 | 8.0 |
| 3" | 76 mm | 200 | 285 | 100 | 200 | 8.0 |
| 4" | 102 mm | 200 | 285 | 100 | 200 | 8.0 |
| 6" | 152 mm | 200 | 285 | 100 | 200 | 8.0 |

GRAY CAST IRON BODY, BRASS DOME 200 mm HIGH, FLASHING RING INTEGRAL WITH GRAVEL STOP.

ROOF DRAIN MODEL : JPI - 127

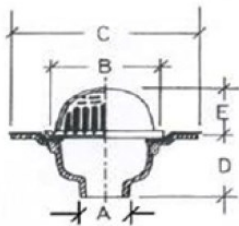

| PIPE SIZE | DIMENSIONS IN MM | | | | | OPEN AREA IN INCH |
|-----------|------------------|-----|-----|----|----|-------------------|
| | A | B | C | D | E | |
| 2" | 51 mm | 170 | 210 | 70 | 85 | 40 |
| 3" | 76 mm | 170 | 210 | 70 | 85 | 40 |
| 4" | 102 mm | 170 | 210 | 70 | 85 | 40 |

GRAY CAST IRON BODY, BRASS DOME 85 mm HIGH, FLASHING RING INTEGRAL WITH GRAVEL STOP

PLANT BOX MODEL : JPI - 128 CI

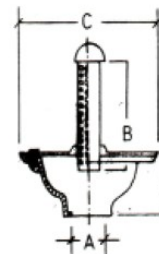

| PIPE SIZE | DIMENSIONS IN MM | | | | OPEN AREA |
|-----------|------------------|-----|-----|----|---------------|
| | A Ø | B | C Ø | D | |
| 2" | 51 mm | 205 | 210 | 70 | 8-10 SQ. INCH |
| 3" | 76 mm | 205 | 210 | 70 | 8-10 SQ. INCH |
| 4" | 102 mm | 205 | 210 | 70 | 8-10 SQ. INCH |

ALL CAST IRON BODY, PERFORATED STAND PIPE WITH INTEGRAL CLAMPING COLLAR

JAMAN® is a registered trademark of JAMAN PRODUCTS INC for all kinds of drains under REG # 4/2001/00008234 and all kinds of manhole, grease traps, cleanouts, gratings, roof basket strainers under REG# 4/2015/00010854

PLANT BOX MODEL : JPI - 128

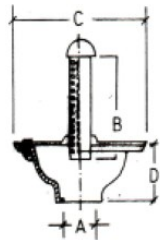

| PIPE SIZE | DIMENSIONS IN MM | | | | OPEN AREA |
|-----------|------------------|-----|-----|----|---------------|
| | A Ø | B | C Ø | D | |
| 2" | 51 mm | 205 | 210 | 70 | 8-10 SQ. INCH |
| 3" | 76 mm | 205 | 210 | 70 | 8-10 SQ. INCH |
| 4" | 102 mm | 205 | 210 | 70 | 8-10 SQ. INCH |

GRAY CAST IRON BODY, PERFORATED STAND PIPE WITH INTEGRAL CLAMPING COLLAR

BALCONY DRAIN MODEL : JPI - 129

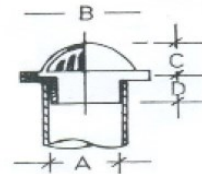

| PIPE SIZE | DIMENSIONS IN MM | | | | OPEN AREA |
|-----------|------------------|-----|----|----|-----------|
| | A | B | C | D | |
| 2" | 51 mm | 125 | 52 | 40 | 4.5 |
| 3" | 76 mm | 125 | 52 | 45 | 6 |
| 4" | 102 mm | 143 | 65 | 50 | 12 |
| 6" | 152 mm | 180 | 85 | 60 | 40 |

GRAY CAST IRON BODY, BRASS DOME STRAINER

GUTTER DRAIN MODEL : JPI - 130

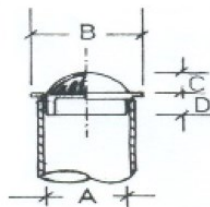

| PIPE SIZE | DIMENSIONS IN MM | | | | OPEN AREA |
|-----------|------------------|-----|----|----|-----------|
| | A | B | C | D | |
| 2" | 51 mm | 68 | 25 | 15 | 3.5 |
| 3" | 76 mm | 93 | 34 | 21 | 4 |
| 4" | 102 mm | 112 | 40 | 21 | 4.5 |

BRASS DOME STRAINER WITH THREAD BRASS HOUSING

CLEAN OUT MODEL : JPI - 131

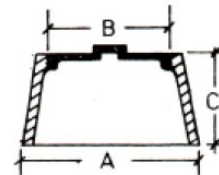

| PIPE SIZE | DIMENSIONS IN MM | | |
|-----------|------------------|-----|----|
| | A Ø | B Ø | C |
| 2" | 51 mm | 49 | 42 |
| 3" | 76 mm | 49 | 43 |
| 4" | 102 mm | 98 | 44 |
| 6" | 152 mm | 141 | 83 |

GRAY CAST IRON WITH BRASS RAISED HEAD CLEAN OUT.

JAMAN® is a registered trademark of JAMAN PRODUCTS INC for all kinds of drains under REG # 4/2001/00008234 and all kinds of manhole, grease traps, cleanouts, gratings, roof basket strainers under REG# 4/2015/00010854

CLEAN OUT MODEL : JPI - 132 SP

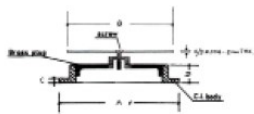
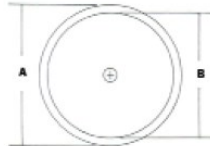

| PIPE SIZE | DIMENSION IN MM | | | |
|-----------|-----------------|-----|---|----|
| | A | B | C | D |
| 2" | 68 | 76 | 5 | 14 |
| 3" | 90 | 76 | 5 | 17 |
| 4" | 115 | 101 | 6 | 17 |
| 6" | 180 | 152 | 6 | 26 |

GRAY CAST IRON HOUSING, BRASS PLUG WITH 2MM THK, ROUND ACCESS COVER (BRASS OR STAINLESS PLATE) ADJUSTABLE TYPE

CLEAN OUT MODEL : JPI - 132

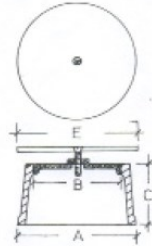

| PIPE SIZE | DIMENSIONS IN MM | | | |
|-----------|------------------|-----|----|------------|
| | A | B | C | E |
| 2" | 51 mm | 49 | 42 | 3" Φ 76 Φ |
| 3" | 76 mm | 69 | 43 | 4" Φ 102 Φ |
| 4" | 102 mm | 98 | 44 | 5" Φ 127 Φ |
| 6" | 152 mm | 141 | 83 | 7" Φ 178 Φ |

GRAY CAST IRON HOUSING, BRASS PLUG WITH 3 mm THK, ROUND ACCESS COVER (BRASS OR STAINLESS PLATE) ADJUSTABLE TYPE

CLEAN OUT MODEL : JPI - 133 SP

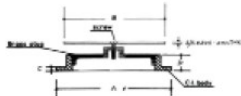
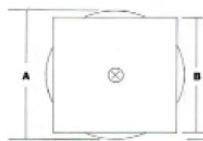

| PIPE SIZE | DIMENSION IN MM | | | |
|-----------|-----------------|---------|---|----|
| | A | BXB | C | D |
| 2" | 68 | 76X76 | 5 | 14 |
| 3" | 90 | 76X76 | 5 | 17 |
| 4" | 115 | 101X101 | 6 | 17 |
| 6" | 180 | 152X152 | 6 | 26 |

GRAY CAST IRON HOUSING, BRASS PLUG WITH 2MM THK, SQUARE ACCESS COVER (BRASS OR STAINLESS PLATE) ADJUSTABLE TYPE

CLEAN OUT MODEL : JPI - 133

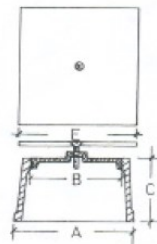
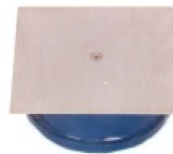

| PIPE SIZE | DIMENSIONS IN MM | | | |
|-----------|------------------|-----|----|-------------------|
| | A | B | C | E X E |
| 2" | 51 mm | 49 | 42 | 3" X 3" 76 X 76 |
| 3" | 76 mm | 69 | 43 | 4" X 4" 102 X 102 |
| 4" | 102 mm | 98 | 44 | 5" X 5" 127 X 127 |
| 6" | 152 mm | 141 | 83 | 7" X 7" 178 X 178 |

GRAY CAST IRON HOUSING, BRASS PLUG WITH 3 mm THK, SQUARE ACCESS COVER (BRASS OR STAINLESS PLATE) ADJUSTABLE TYPE

JAMAN® is a registered trademark of JAMAN PRODUCTS INC for all kinds of drains under REG # 4/2001/0008234 and all kinds of manhole, grease traps, cleanouts, gratings, roof basket strainers under REG# 4/2015/00010854

CLEAN OUT MODEL : JPI - 134 SP

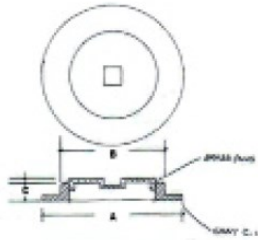

| PIPE SIZE | DIMENSIONS IN MM | | |
|-----------|------------------|-----|----|
| | A Ø | B Ø | C |
| 2" | 68 mm | 53 | 14 |
| 3" | 90 mm | 75 | 17 |
| 4" | 115 mm | 100 | 17 |
| 6" | 180 mm | 140 | 26 |

**GRAY CAST IRON WITH BRASS PLUG
COUNTERSUNK CLEAN OUT**

CLEAN OUT MODEL : JPI - 134

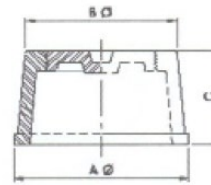

| PIPE SIZE | DIMENSIONS IN MM | | |
|-----------|------------------|-----|----|
| | A Ø | B Ø | C |
| 2" | 51 mm | 49 | 42 |
| 3" | 76 mm | 69 | 43 |
| 4" | 102 mm | 98 | 44 |
| 6" | 152 mm | 141 | 83 |

**GRAY CAST IRON WITH BRASS
COUNTERSUNK CLEAN OUT.**

CLEAN OUT MODEL : JPI - 135 SP

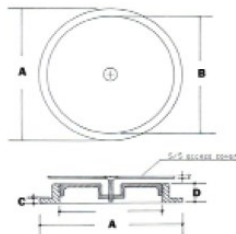

| PIPE SIZE | DIMENSION IN MM | | | |
|-----------|-----------------|-----|---|----|
| | A | B | C | D |
| 2" | 68 | 76 | 5 | 14 |
| 3" | 90 | 76 | 5 | 17 |
| 4" | 115 | 101 | 6 | 17 |
| 6" | 180 | 152 | 6 | 26 |

**GRAY CAST IRON HOUSING, BRASS PLUG WITH 2MM THK,
ROUND ACCESS COVER (BRASS OR STAINLESS PLATE) ADJUSTABLE TYPE**

CLEAN OUT MODEL : JPI - 135

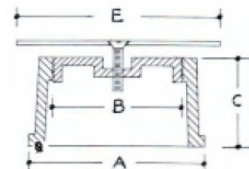

| PIPE SIZE | DIMENSIONS IN MM | | | |
|-----------|------------------|-----|----|-------------|
| | A | B | C | E |
| 2" | 51 mm | 49 | 42 | 3"R 76 Ø |
| 3" | 76 mm | 69 | 43 | 4"R 102 Ø |
| 4" | 102 mm | 98 | 44 | 4.5"R 127 Ø |
| 6" | 152 mm | 141 | 83 | 7"R 178 Ø |

**GRAY CAST IRON HOUSING, BRASS PLUG WITH 3 mm THK,
ROUND ACCESS COVER (BRASS OR STAINLESS PLATE)
ADJUSTABLE TYPE**

JAMAN® is a registered trademark of JAMAN PRODUCTS INC for all kinds of drains under REG # 4/2001/00008234 and all kinds of manhole, grease traps, cleanouts, gratings, roof basket strainers under REG# 4/2015/00010854

CLEAN OUT MODEL : JPI - 136 SP

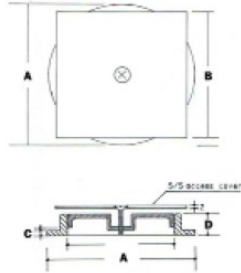

| DIMENSION IN MM | | | | |
|-----------------|-----|---------|---|----|
| PIPE SIZE | A | BXB | C | D |
| 2" | 68 | 76X76 | 5 | 14 |
| 3" | 90 | 76X76 | 5 | 17 |
| 4" | 115 | 101X101 | 6 | 17 |
| 6" | 180 | 152X152 | 6 | 26 |

GRAY CAST IRON HOUSING, BRASS PLUG WITH 2MM THK, SQUARE ACCESS COVER (BRASS OR STAINLESS PLATE) ADJUSTABLE TYPE

CLEAN OUT MODEL : JPI - 136

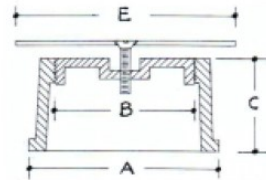

| PIPE SIZE | DIMENSIONS IN MM | | | |
|-----------|------------------|-----|----|-------------------|
| | A | B | C | E |
| 2" | 51 mm | 49 | 42 | 3" x 3" 76 x 76 |
| 3" | 76 mm | 69 | 43 | 4" x 4" 102 x 102 |
| 4" | 102 mm | 98 | 44 | 5" x 5" 127 x 127 |
| 6" | 152 mm | 141 | 83 | 7" x 7" 178 x 178 |

GRAY CAST IRON HOUSING, BRASS PLUG WITH 2MM THK, SQUARE ACCESS COVER (BRASS OR STAINLESS PLATE) ADJUSTABLE TYPE

ACCESS COVER MODEL : JPI - 137

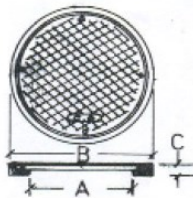

| PIPE SIZE | DIMENSIONS IN MM | | |
|-----------|------------------|------------|----|
| | A | B | C |
| 2" | 51 mm | 3" Φ 76 Φ | 7 |
| 3" | 76 mm | 4" Φ 102 Φ | 8 |
| 4" | 102 mm | 5" Φ 127 Φ | 10 |
| 6" | 152 mm | 7" Φ 178 Φ | 12 |

SOLID BRASS ACCESS COVER ROUND TYPE

STAINLESS FLOOR CLEAN OUT MODEL : JPI - 138 SP

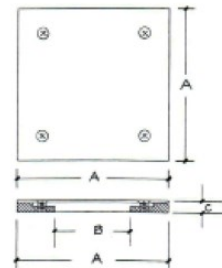

| A | B | C |
|---------|--------|------|
| 4" x 4" | 2 1/8" | 3/8" |
| 5" x 5" | 3 1/8" | 3/8" |
| 6" x 6" | 4 1/8" | 3/8" |

FLOOR CLEAN OUT STAINLESS COVER WITH CAST IRON BASE

JAMAN® is a registered trademark of JAMAN PRODUCTS INC for all kinds of drains under REG # 4/2001/00008234 and all kinds of manhole, grease traps, cleanouts, gratings, roof basket strainers under REG# 4/2015/00010854

ACCESS COVER MODEL : JPI - 138

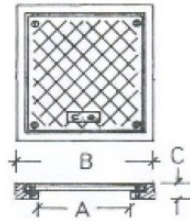

| PIPE SIZE | DIMENSIONS IN MM | | | |
|-----------|------------------|---------|-----------|----|
| | A | B X B | C | |
| 3" | 76 mm | 4" X 4" | 102 X 102 | 8 |
| 4" | 102 mm | 5" X 5" | 127 X 127 | 9 |
| 6" | 152 mm | 7" X 7" | 203 X 203 | 10 |

SOLID BRASS ACCESS COVER SQUARE TYPE

DECK DRAIN MODEL : JPI - 139

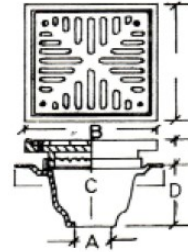

| PIPE SIZE | DIMENSIONS IN MM | | | | OPEN AREA IN INCH. | |
|-----------|------------------|-----------|-----|-----|--------------------|----|
| | A | B | C | D | | |
| 2" | 51 mm | 8" X 8" | 205 | 296 | 130 | 20 |
| 3" | 76 mm | 8" X 8" | 203 | 296 | 130 | 20 |
| 4" | 102 mm | 10" X 10" | 254 | 296 | 130 | 32 |
| 6" | 152 mm | 12" X 12" | 305 | 296 | 130 | 48 |

GRAY CAST IRON BODY, BRASS SQUARE PROMENADE FRAME AND SLOTTED GRATE, FLASHING RING INTEGRAL WITH GRAVEL GUARD.

SCUPPER DRAIN 90° MODEL : JPI - 140

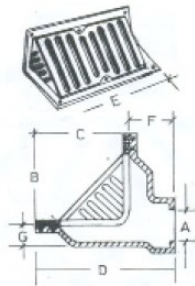

| PIPE SIZE | DIMENSIONS IN MM | | | | | | | OPEN AREA IN INCH |
|-----------|------------------|-----|-----|-----|-----|-----|----|-------------------|
| | A | B | C | D | E | F | G | |
| 2" | 51 mm | 76 | 76 | 180 | 152 | 100 | 40 | 12 |
| 3" | 76 mm | 76 | 76 | 180 | 152 | 100 | 40 | 16 |
| 4" | 102 mm | 95 | 95 | 180 | 190 | 100 | 40 | 20 |
| 6" | 152 mm | 135 | 135 | 230 | 300 | 110 | 50 | 48 |

SCUPPER DRAIN GRAY CAST IRON BODY WITH BACK OUTLET, BRASS OBLIQUE TYPE STRAINER WITH 90° COMBINATION FRAME AND FLASHING CLAMP

SCUPPER DRAIN MODEL : JPI - 141

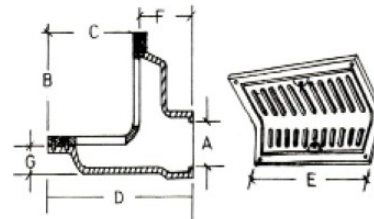
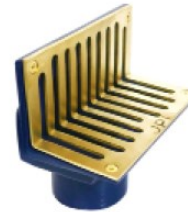

| PIPE SIZE | DIMENSIONS IN MM | | | | | | | OPEN AREA IN INCH. |
|-----------|------------------|-----|-----|-----|-----|-----|----|--------------------|
| | A | B | C | D | E | F | G | |
| 2" | 51 mm | 76 | 76 | 180 | 152 | 100 | 40 | 12 |
| 3" | 76 mm | 76 | 76 | 180 | 152 | 100 | 40 | 16 |
| 4" | 102 mm | 95 | 95 | 180 | 190 | 100 | 40 | 20 |
| 6" | 152 mm | 135 | 135 | 230 | 300 | 110 | 50 | 48 |

SCUPPER DRAIN, GRAY CAST IRON BODY WITH BACK OUTLET, BRASS FLUSH TYPE STRAINER WITH 90° COMBINATION FRAME AND FLASHING CLAMP.

JAMAN® is a registered trademark of JAMAN PRODUCTS INC for all kinds of drains under REG # 4/2001/00008234 and all kinds of manhole, grease traps, cleanouts, gratings, roof basket strainers under REG# 4/2015/00010854

SCUPPER DRAIN MODEL : JPI - 142

SCUPPER DRAIN 45° MODEL : JPI - 143

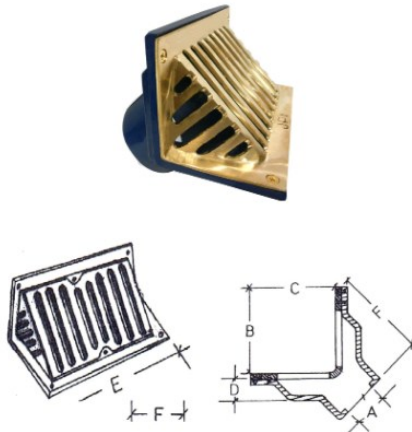

| PIPE SIZE | DIMENSIONS IN MM | | | | | | OPEN AREA IN INCH |
|-----------|------------------|-----|-----|----|-----|-----|----------------------|
| | A | B | C | D | E | F | |
| 2" | 51 mm | 76 | 76 | 40 | 152 | 130 | 12 |
| 3" | 76 mm | 76 | 76 | 40 | 152 | 130 | 16 |
| 4" | 102 mm | 95 | 95 | 40 | 190 | 150 | 20 |
| 6" | 152 mm | 135 | 135 | 50 | 300 | 190 | 48 |

SCUPPER DRAIN GRAY CAST IRON BODY WITH 45° OUTLET, BRASS FLUSH TYPE STRAINER WITH 90° COMBINATION FRAME AND FLASHING CLAMP



| PIPE SIZE | DIMENSIONS IN MM | | | | | | OPEN AREA IN INCH |
|-----------|------------------|-----|-----|----|-----|-----|----------------------|
| | A | B | C | D | E | F | |
| 2" | 51 mm | 76 | 76 | 40 | 152 | 130 | 12 |
| 3" | 76 mm | 76 | 76 | 40 | 152 | 130 | 16 |
| 4" | 102 mm | 95 | 95 | 40 | 190 | 150 | 20 |
| 6" | 152 mm | 135 | 135 | 50 | 300 | 190 | 48 |

SCUPPER DRAIN GRAY CAST IRON BODY WITH 45° OUTLET, BRASS FLUSH TYPE STRAINER WITH 90° COMBINATION FRAME AND FLASHING CLAMP

PARKING DRAIN MODEL : JPI - 144

PARKING DRAIN MODEL : JPI - 145



| PIPE SIZE | DIMENSIONS IN MM | | | | OPEN AREA IN INCH | |
|-----------|------------------|------|-------|-----|----------------------|-----|
| | A | B | C | D | | |
| 2" | 51 mm | 8" φ | 203 φ | 265 | 115 | 2.2 |
| 3" | 76 mm | 8" φ | 203 φ | 265 | 115 | 2.2 |
| 4" | 102 mm | 8" φ | 203 φ | 265 | 115 | 2.2 |
| 6" | 152 mm | 8" φ | 203 φ | 265 | 125 | 2.2 |

GRAY CAST IRON WITH INTEGRAL CLAMPING COLLAR AND LOOSE SET GRATE WITH STANDING SEDIMENT BUCKET.

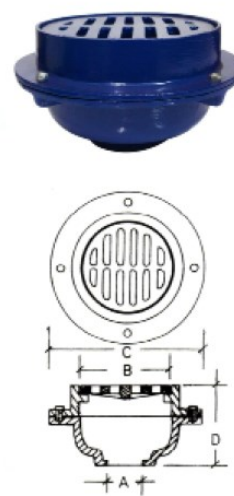

| PIPE SIZE | DIMENSIONS IN MM | | | | OPEN AREA IN INCH | |
|-----------|------------------|------|-------|-----|----------------------|-----|
| | A | B | C | D | | |
| 2" | 51 mm | 8" φ | 203 φ | 265 | 150 | 2.2 |
| 3" | 76 mm | 8" φ | 203 φ | 265 | 150 | 2.2 |
| 4" | 102 mm | 8" φ | 203 φ | 265 | 150 | 2.2 |

GRAY CAST IRON WITH INTEGRAL CLAMPING COLLAR AND LOOSE SET GRATE

JAMAN® is a registered trademark of JAMAN PRODUCTS INC for all kinds of drains under REG # 4/2001/00008234 and all kinds of manhole, grease traps, cleanouts, gratings, roof basket strainers under REG# 4/2015/00010854

PARKING DRAIN MODEL : JPI - 146

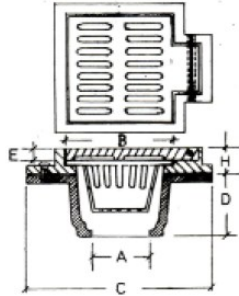

| PIPE SIZE | DIMENSIONS IN MM | | | | | OPEN AREA IN INCH | |
|-----------|------------------|---------|-----------|-----|----|----------------------|----|
| | A | B | C | D | E | | |
| 2" | 51 mm | 8" X 8" | 203 X 203 | 260 | 85 | 17 | 22 |
| 3" | 76 mm | 8" X 8" | 203 X 203 | 260 | 85 | 17 | 22 |
| 4" | 102 mm | 8" X 8" | 203 X 203 | 260 | 85 | 17 | 22 |

GRAY CAST IRON WITH CLAMPING FRAME, HINGE, BASKET AND LOOSE SET GRATE

PARKING DRAIN MODEL : JPI - 147

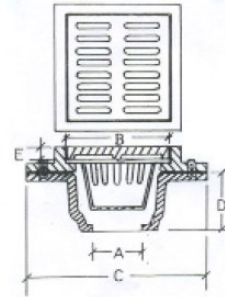

| PIPE SIZE | DIMENSIONS IN MM | | | | | OPEN AREA IN INCH | |
|-----------|------------------|---------|-----------|-----|----|----------------------|----|
| | A | B | C | D | E | | |
| 2" | 51 mm | 8" X 8" | 203 X 203 | 260 | 85 | 17 | 22 |
| 3" | 76 mm | 8" X 8" | 203 X 203 | 260 | 85 | 17 | 22 |
| 4" | 102 mm | 8" X 8" | 203 X 203 | 260 | 85 | 17 | 22 |

GRAY CAST IRON WITH INTEGRAL CLAMPING COLLAR AND LOOSE SET GRATE. WITH HINGE AND SEDIMENT BUCKET

STEEL GRATING MODEL : JPI - 149 GI

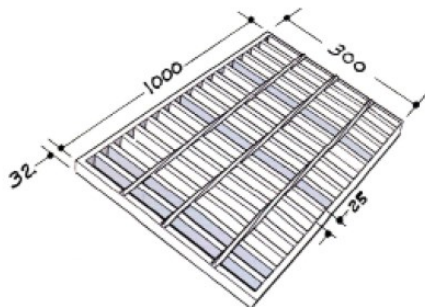

STEEL GRATING COVER 300MM X 1000MM WITH HOT DIP GALVANIZE AND TWISTED ROD (TRAFFIC TYPE)

MATERIAL USE : STEEL FLAT BAR 6MM X 32MM

TRENCH GRATING MODEL : JPI - 149

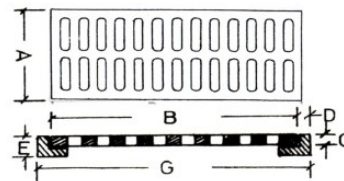

| MODEL NUMBER | DIMENSIONS IN MM | | | | | |
|--------------|------------------|------|----|----|----|-----|
| | A | B | C | D | E | G |
| 149 - A | 150 | 400 | 12 | 8 | 20 | 166 |
| 149 - B | 200 | 500 | 15 | 10 | 25 | 220 |
| 149 - C | 250 | 600 | 17 | 12 | 29 | 274 |
| 149 - D | 300 | 600 | 25 | 15 | 40 | 330 |
| 149 - E | 350 | 800 | 30 | 20 | 50 | 390 |
| 149 - F | 400 | 1000 | 50 | 25 | 75 | 450 |

GRAY CAST IRON TRENCH GRATING WITH FRAME

JAMAN® is a registered trademark of JAMAN PRODUCTS INC for all kinds of drains under REG # 4/2001/00008234 and all kinds of manhole, grease traps, cleanouts, gratings, roof basket strainers under REG# 4/2015/00010854

**MANHOLE COVER WITH HINGE
MODEL : JPI - 150**

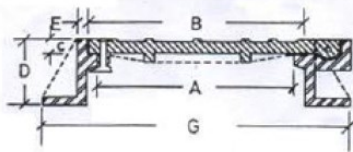

| MODEL NUMBER | DIMENSIONS IN MM | | | | | | OPEN AREA IN INCH |
|--------------|------------------|-----|----|-----|----|------|-------------------|
| | A | B | C | D | E | G | |
| 150 - A | 610 | 660 | 32 | 127 | 20 | 815 | 24 Φ |
| 150 - B | 660 | 710 | 32 | 127 | 20 | 860 | 26 Φ |
| 150 - C | 711 | 775 | 38 | 150 | 25 | 1000 | 28 Φ |
| 150 - D | 762 | 826 | 38 | 150 | 25 | 1000 | 30 Φ |

HEAVY DUTY MATERIAL : GRAY CAST IRON

MANHOLE COVER MODEL : JPI - 151

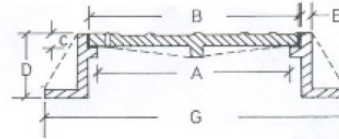

| MODEL NUMBER | DIMENSIONS IN MM | | | | | | OPEN AREA IN INCH |
|--------------|------------------|-----|----|-----|----|------|-------------------|
| | A | B | C | D | E | G | |
| 151 - A | 610 | 660 | 32 | 127 | 20 | 815 | 24 Φ |
| 151 - B | 660 | 710 | 32 | 127 | 20 | 860 | 26 Φ |
| 151 - C | 711 | 775 | 38 | 150 | 25 | 1000 | 28 Φ |
| 151 - D | 762 | 826 | 38 | 150 | 25 | 1000 | 30 Φ |

HEAVY DUTY MATERIAL : GRAY CAST IRON

CATCH BASIN MODEL : JPI - 152

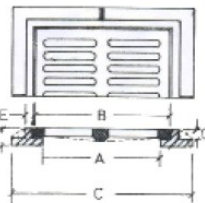

| MODEL NUMBER | DIMENSIONS IN MM | | | | | | OPEN AREA IN INCH |
|--------------|------------------|-----------|-----------|----|----|----|-------------------|
| | A | B | C | D | E | G | |
| 152 - A | 305 X 305 | 345 X 345 | 405 X 405 | 25 | 10 | 12 | 12 X 12 |
| 152 - B | 355 X 355 | 395 X 395 | 455 X 455 | 25 | 10 | 12 | 14 X 14 |
| 152 - C | 406 X 406 | 446 X 446 | 510 X 510 | 27 | 12 | 12 | 16 X 16 |
| 152 - D | 457 X 457 | 497 X 497 | 560 X 560 | 31 | 12 | 16 | 18 X 18 |
| 152 - E | 508 X 508 | 558 X 558 | 640 X 640 | 34 | 15 | 16 | 20 X 20 |
| 152 - F | 558 X 558 | 608 X 608 | 690 X 690 | 38 | 15 | 20 | 22 X 22 |
| 152 - G | 610 X 610 | 660 X 660 | 750 X 750 | 38 | 15 | 20 | 24 X 24 |

SQUARE TYPE MATERIAL : GRAY CAST IRON

**MANHOLE COVER WITH HINGE
MODEL : JPI - 154**

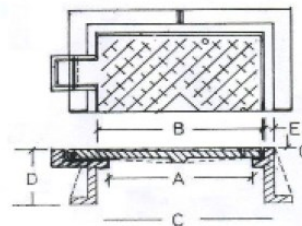

| MODEL NUMBER | DIMENSIONS IN MM | | | | | | OPEN AREA IN INCH |
|--------------|------------------|-----------|-----------|----|----|----|-------------------|
| | A | B | C | D | E | G | |
| 154 - A | 305 X 305 | 345 X 345 | 430 X 430 | 70 | 10 | 12 | 12 X 12 |
| 154 - B | 355 X 355 | 395 X 395 | 480 X 480 | 70 | 10 | 12 | 14 X 14 |
| 154 - C | 406 X 406 | 446 X 446 | 530 X 530 | 70 | 12 | 12 | 16 X 16 |
| 154 - D | 457 X 457 | 490 X 490 | 580 X 580 | 80 | 12 | 16 | 18 X 18 |
| 154 - E | 508 X 508 | 558 X 558 | 650 X 650 | 80 | 15 | 16 | 20 X 20 |
| 154 - F | 558 X 558 | 608 X 608 | 700 X 700 | 90 | 15 | 20 | 22 X 22 |
| 154 - G | 610 X 610 | 660 X 660 | 750 X 750 | 90 | 15 | 20 | 24 X 24 |

SQUARE TYPE MATERIAL : GRAY CAST IRON

JAMAN® is a registered trademark of JAMAN PRODUCTS INC for all kinds of drains under REG # 4/2001/00008234 and all kinds of manhole, grease traps, cleanouts, gratings, roof basket strainers under REG# 4/2015/00010854

VALVE BOX MODEL : JPI - 155 VB

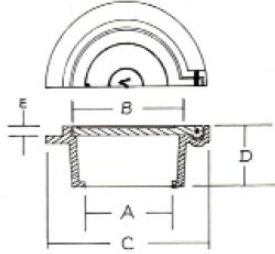

| PIPE SIZE | | DIMENSION IN MM | | | |
|-----------|-------|-----------------|-----|----|----|
| A | | B | C | D | E |
| 4" | 100mm | 150 | 220 | 64 | 12 |
| 6" | 150mm | 200 | 270 | 75 | 12 |
| 8" | 200mm | 250 | 320 | 70 | 12 |

CAST IRON VALVE BOX WITH HINGE

MANHOLE COVER MODEL : JPI - 157

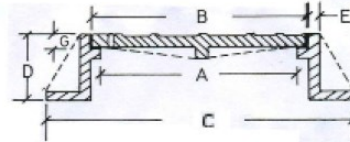

| MODEL NUMBER | DIMENSIONS IN MM | | | | | | IN INCHES |
|--------------|------------------|-----|-----|----|----|----|-----------|
| | A | B | C | D | E | G | |
| 157 - A | 305 | 345 | 430 | 70 | 10 | 12 | 12 φ |
| 157 - B | 355 | 395 | 480 | 70 | 10 | 12 | 14 φ |
| 157 - C | 406 | 446 | 530 | 70 | 12 | 12 | 16 φ |
| 157 - D | 457 | 497 | 580 | 80 | 12 | 16 | 18 φ |
| 157 - E | 508 | 558 | 650 | 80 | 15 | 16 | 20 φ |
| 157 - F | 558 | 608 | 700 | 90 | 15 | 20 | 22 φ |
| 157 - G | 610 | 660 | 750 | 90 | 15 | 20 | 24 φ |

ROUND TYPE MATERIAL : GRAY CAST IRON

CISTERN COVER MODEL : JPI - 158

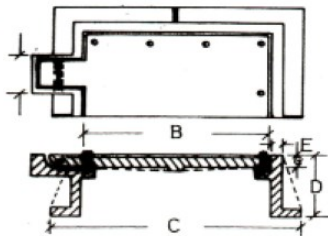

| MODEL NUMBER | DIMENSION IN MM | | | | | | IN INCHES |
|--------------|-----------------|-----------|-----------|----|----|----|-----------|
| | A | B | C | D | E | G | |
| 158 - A | 305 X 305 | 345 X 345 | 430 X 430 | 70 | 10 | 12 | 12 X 12 |
| 158 - B | 355 X 355 | 395 X 395 | 480 X 480 | 70 | 10 | 12 | 14 X 14 |
| 158 - C | 406 X 406 | 446 X 446 | 530 X 530 | 70 | 12 | 12 | 16 X 16 |
| 158 - D | 457 X 457 | 497 X 497 | 580 X 580 | 80 | 12 | 16 | 18 X 18 |
| 158 - E | 508 X 508 | 558 X 558 | 650 X 650 | 80 | 15 | 16 | 20 X 20 |
| 158 - F | 558 X 558 | 608 X 608 | 700 X 700 | 90 | 15 | 20 | 22 X 22 |
| 158 - G | 610 X 610 | 660 X 660 | 750 X 750 | 90 | 15 | 20 | 24 X 24 |

SQUARE TYPE MATERIAL : GRAY CAST IRON WITH S/S BOLT, AND GASKET.

CISTERN COVER MODEL : JPI - 161

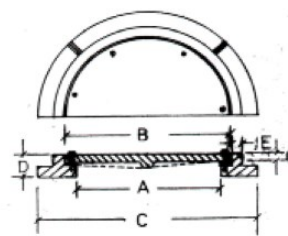

| MODEL NUMBER | DIMENSIONS IN MM | | | | | | IN INCHES |
|--------------|------------------|-----|-----|----|----|----|-----------|
| | A | B | C | D | E | G | |
| 161 - A | 305 | 345 | 405 | 27 | 10 | 12 | 12 φ |
| 161 - B | 355 | 395 | 455 | 27 | 10 | 12 | 14 φ |
| 161 - C | 406 | 446 | 510 | 29 | 12 | 12 | 16 φ |
| 161 - D | 457 | 497 | 560 | 33 | 12 | 16 | 18 φ |
| 161 - E | 508 | 558 | 640 | 36 | 15 | 16 | 20 φ |
| 161 - F | 558 | 608 | 690 | 40 | 15 | 20 | 22 φ |
| 161 - G | 610 | 660 | 750 | 40 | 15 | 20 | 24 φ |

ROUND TYPE MATERIAL : GRAY CAST IRON WITH S/S BOLT, AND GASKET.

JAMAN® is a registered trademark of JAMAN PRODUCTS INC for all kinds of drains under REG # 4/2001/00008234 and all kinds of manhole, grease traps, cleanouts, gratings, roof basket strainers under REG# 4/2015/00010854

JAMAN PRODUCTS INCORPORATED
STAINLESS GREASE TRAP MODEL : JPI - 162 - S

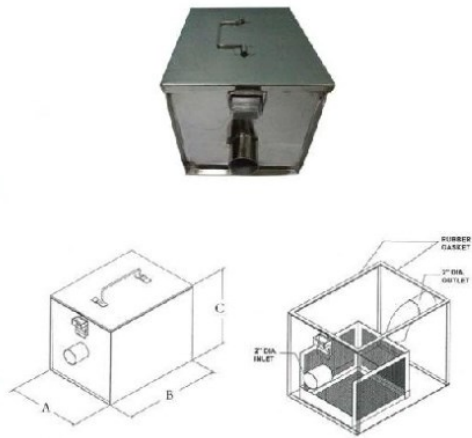

| FLOW RATE GPM | PIPE SIZE | WIDTH OF BODY | | | DIMENSIONS IN INCHES | | |
|------------------|-----------|---------------|---------|---------|----------------------|---|---|
| | | A | B | C | A | B | C |
| 4 | 2 | 9" | 12" | 9" | | | |
| 5 | 2 | 10" | 13" | 9" | | | |
| 7 | 2 | 10" | 15 1/2" | 10 1/2" | | | |
| 10 | 2 | 13" | 25" | 12" | | | |
| 15 | 2 | 14" | 18" | 12" | | | |
| 20 | 3 | 20" | 24" | 14" | | | |
| 25 | 3 | 20" | 27" | 16" | | | |
| 35 | 3 | 22" | 31" | 21" | | | |

MATERIALS : STAINLESS STEEL 304

JAMAN PRODUCTS INCORPORATED
GREASE TRAP MODEL : JPI - 162

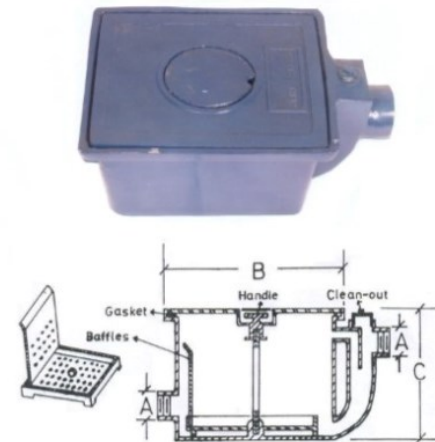

| FLOW RATE GPM | PIPE SIZE | DIMENSIONS IN INCHES | | | WIDTH OF BODY |
|------------------|-----------|----------------------|-------|-------|---------------|
| | | A | B | C | |
| 4 | 2 | 14.75 | 9.00 | 12.00 | |
| 7 | 2 | 15.00 | 11.00 | 12.00 | |
| 10 | 2 | 16.00 | 11.75 | 14.00 | |
| 15 | 2 | 18.50 | 12.00 | 15.75 | |
| 20 | 3 | 24.75 | 15.00 | 20.00 | |
| 25 | 4 | 27.00 | 18.00 | 20.25 | |
| 35 | 4 | 30.50 | 21.00 | 20.50 | |

MATERIALS : GRAY CAST IRON



**STAINLESS STEEL 304
LADDER RUNG 19mmØ**

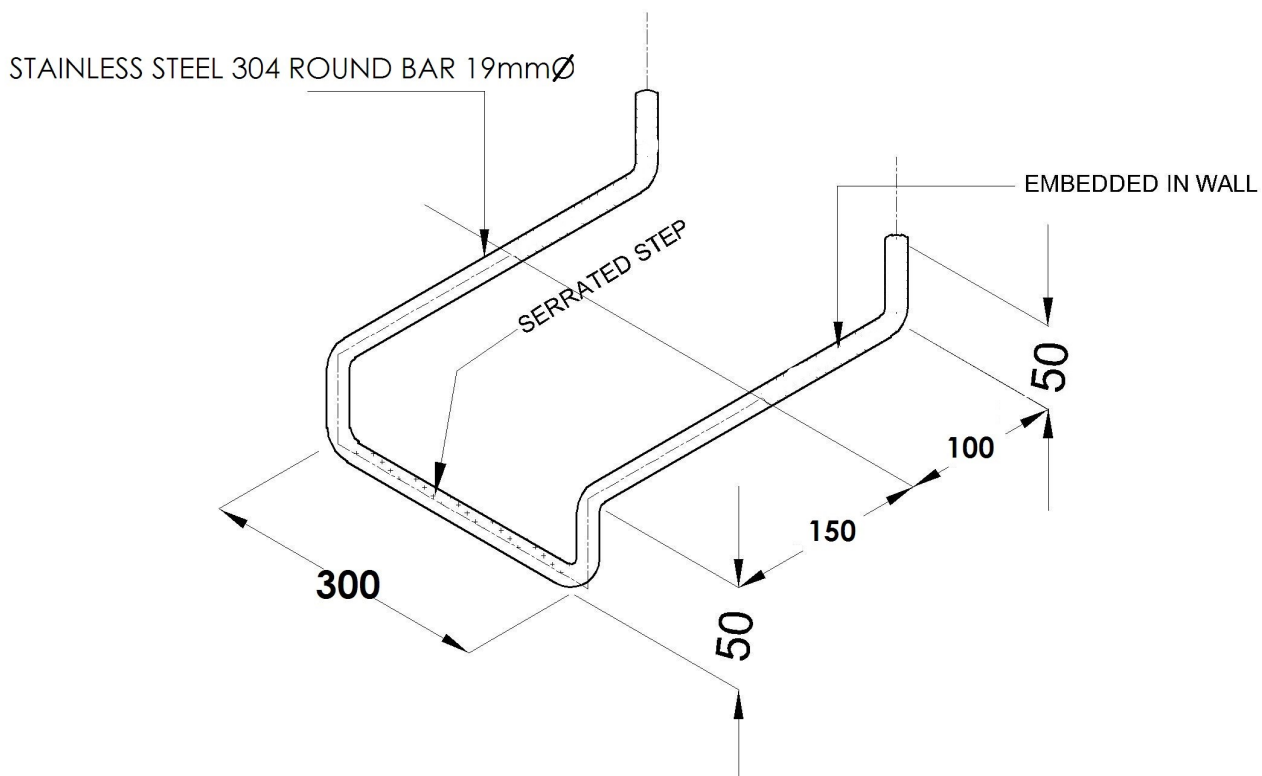



**STAINLESS STEEL 316
LADDER RUNG 19mmØ**

